

# EIKI

DLP™ PROJECTOR

MODEL **EIP-1000T**

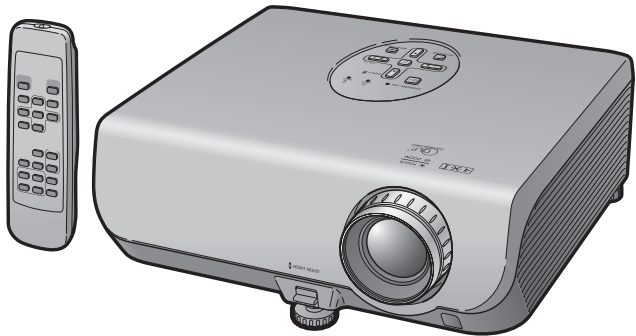

**OWNER'S MANUAL**

**EIKI INDUSTRIAL CO., LTD.**



## IMPORTANT

- For your assistance in reporting the loss or theft of your Projector, please record the Serial Number located on the bottom of the projector and retain this information.
- Before recycling the packaging, please ensure that you have checked the contents of the carton thoroughly against the list of "Supplied accessories" on page 10.

**Model No.: EIP-1000T**

**Serial No.:**

### **SPECIAL NOTE FOR USERS IN THE U.K.**

The mains lead of this product is fitted with a non-rewireable (moulded) plug incorporating a 10A fuse. Should the fuse need to be replaced, a BSI or ASTA approved BS 1362 fuse marked  or  and of the same rating as above, which is also indicated on the pin face of the plug, must be used.

Always refit the fuse cover after replacing the fuse. Never use the plug without the fuse cover fitted.

In the unlikely event of the socket outlet in your home not being compatible with the plug supplied, cut off the mains plug and fit an appropriate type.

### **DANGER:**

The fuse from the cut-off plug should be removed and the cut-off plug destroyed immediately and disposed of in a safe manner.

Under no circumstances should the cut-off plug be inserted elsewhere into a 13A socket outlet, as a serious electric shock may occur.

To fit an appropriate plug to the mains lead, follow the instructions below:

### **WARNING:**

THIS APPARATUS MUST BE EARTHED.

### **IMPORTANT:**

The wires in this mains lead are coloured in accordance with the following code:

Green-and-yellow	: Earth
Blue	: Neutral
Brown	: Live

As the colours of the wires in the mains lead of this apparatus may not correspond with the coloured markings identifying the terminals in your plug proceed as follows:

- The wire which is coloured green-and-yellow must be connected to the terminal in the plug which is marked by the letter E or by the safety earth symbol  or coloured green or green-and-yellow.
- The wire which is coloured blue must be connected to the terminal which is marked with the letter N or coloured black.
- The wire which is coloured brown must be connected to the terminal which is marked with the letter L or coloured red.

IF YOU HAVE ANY DOUBT, CONSULT A QUALIFIED ELECTRICIAN.

This apparatus complies with the requirements of Council Directives 89/336/EEC and 73/23/EEC as amended by Council Directive 93/68/EEC.

Dieses Gerät entspricht den Anforderungen der EG-Richtlinien 89/336/EWG und 73/23/EWG mit Änderung 93/68/EWG.

Ce matériel répond aux exigences contenues dans les directives 89/336/CEE et 73/23/CEE modifiées par la directive 93/68/CEE.

Dit apparaat voldoet aan de eisen van de richtlijnen 89/336/EEG en 73/23/EEG, gewijzigd door 93/68/EEG.

Dette udstyr overholder kravene i direktiv nr. 89/336/EEC og 73/23/EEC med tillæg nr. 93/68/EEC.

Quest' apparecchio è conforme ai requisiti delle direttive 89/336/EEC e 73/23/EEC, come emendata dalla direttiva 93/68/EEC.

Αυτή η συσκευή συμμορφώνεται με τις απαιτήσεις των οδηγιών του Συμβουλίου 89/336/ΕΟΚ και 73/23/ΕΟΚ όπως τροποποιήθηκαν από την οδηγία του Συμβουλίου 93/68/ΕΟΚ.

Este equipamento obedece às exigências das directivas 89/336/CEE e 73/23/CEE, na sua versão corrigida pela directiva 93/68/CEE.

Este aparato satisface las exigencias de las Directivas 89/336/CEE y 73/23/CEE, modificadas por medio de la 93/68/CEE.

Denna utrustning uppfyller kraven enligt riktlinjerna 89/336/EEC och 73/23/EEC så som kompletteras av 93/68/EEC.

Dette produktet oppfyller betingelsene i direktivene 89/336/EEC og 73/23/EEC i endringen 93/68/EEC.

Tämä laite täyttää direktiivien 89/336/EEC ja 73/23/EEC vaatimukset, joita on muutettu direktiivillä 93/68/EEC.

Bu cihaz Konsey Direktifi 93/68/EEC tarafından düzeltilen 89/336/EEC ve 73/23/EEC Konsey Direktiflerinin gerekliliklerine uygundur.

Tento přístroj je v souladu s požadavky směrnic rady 89/336/EEC a 73/23/EEC, tak jak byly upraveny směrnicí rady 93/68/EEC.

See seade on vastavuses Nõukogu Direktiivis nr 89/336/EEC ja 73/23/EEC esitatud nõuetega, vastavalt Nõukogu Direktiivis nr 93/68/EEC esitatud parandustele

Ez a készülék megfelel a Tanács által kiadott, 89/336/EGK és 73/23/EGK Irányelveknek és az utóbbi módosító 93/68/EGK Irányelvnek

Ši ierice atbilst tehnikam prasibam pec 89/336/EEC un 73/23/EEC direktivam papildinats ar direktivu 93/68/EEC.

Šis prietaisas atitinka ES Tarybos direktyvu 89/336/EEC ir 73/23/EEC patikslintos direktyvos 93/68/EEC reikalavimus.

To urządzenie spełnia wymagania dyrektyw 89/336/EEC i 73/23/EEC wraz z poprawkami dyrektywy 93/68/EEC.

Tento přístroj je v súlade s požiadavkami smerníc rady 89/336/EEC a 73/23/EEC tak ako boli upravené smernicou rady 93/68/EEC.

Ta aparat je v skladu z zahtevami Direktiv Sveta 89/336/EEC in 73/23/EEC kot je navedeno v dopolnilu k Direktivi Sveta 93/68/EEC.

Before using the projector, please read this owner's manual carefully.

# Introduction

ENGLISH

## 1. WARRANTY

This is to assure that you immediately receive the full benefit of the parts, service and labor warranty applicable to your purchase.

## 2. CONSUMER PRODUCT SAFETY ACT

To ensure that you will promptly receive any safety notification of inspection, modification, or recall that EIKI may be required to give under the 1972 Consumer Product Safety Act, PLEASE READ CAREFULLY THE IMPORTANT "LIMITED WARRANTY" CLAUSE.



U.S.A. ONLY

**WARNING:** High brightness light source. Do not stare into the beam of light, or view directly. Be especially careful that children do not stare directly into the beam of light.



**WARNING:** To reduce the risk of fire or electric shock, do not expose this product to rain or moisture.

See bottom of projector.

	<b>CAUTION</b> RISK OF ELECTRIC SHOCK. DO NOT REMOVE SCREWS EXCEPT SPECIFIED USER SERVICE SCREW.	
<b>CAUTION: TO REDUCE THE RISK OF ELECTRIC SHOCK, DO NOT REMOVE COVER. NO USER-SERVICEABLE PARTS EXCEPT LAMP UNIT. REFER SERVICING TO QUALIFIED SERVICE PERSONNEL.</b>		



The lightning flash with arrowhead symbol, within an equilateral triangle, is intended to alert the user to the presence of uninsulated "dangerous voltage" within the product's enclosure that may be of sufficient magnitude to constitute a risk or electric shock to persons.



The exclamation point within a triangle is intended to alert the user to the presence of important operating and maintenance (servicing) instructions in the literature accompanying the product.

**WARNING:** FCC Regulations state that any unauthorized changes or modifications to this equipment not expressly approved by the manufacturer could void the user's authority to operate this equipment.

U.S.A. ONLY

## **WARNING:**

The cooling fan in this projector continues to run for about 90 seconds after the projector enters standby mode. During normal operation, when putting the projector into standby mode always use the STANDBY-ON button on the projector or the STANDBY button on the remote control. Ensure the cooling fan has stopped before disconnecting the power cord.

**DURING NORMAL OPERATION, NEVER TURN THE PROJECTOR OFF BY DISCONNECTING THE POWER CORD. FAILURE TO OBSERVE THIS WILL RESULT IN PREMATURE LAMP FAILURE.**

## **INFORMATION**

This equipment has been tested and found to comply with the limits for a Class B digital device, pursuant to Part 15 of the FCC Rules. These limits are designed to provide reasonable protection against harmful interference in a residential installation. This equipment generates, uses, and can radiate radio frequency energy and, if not installed and used in accordance with the owner's manual, may cause harmful interference to radio communications. However, there is no guarantee that interference will not occur in a particular installation. If this equipment does cause harmful interference to radio or television reception, which can be determined by turning the equipment off and on, the user is encouraged to try to correct the interference by one or more of the following measures:

- Reorient or relocate the receiving antenna.
- Increase the separation between the equipment and the receiver.
- Connect the equipment into an outlet on a circuit different from that to which the receiver is connected.
- Consult the dealer or an experienced radio/TV technician for help.

**U.S.A. ONLY**

## **Declaration of conformity**

EIKI PROJECTOR, MODEL EIP-1000T

This device complies with Part 15 of the FCC rules. Operation is subject to the following conditions: (1) This device may not cause harmful interference, and (2) this device must accept any interference received, including interference that may cause undesired operation.

Responsible Party:

EIKI INTERNATIONAL, INC.  
30251 Esperanza Rancho Santa Margarita, CA 92688-2132  
TEL: 800-242-3454

**U.S.A. ONLY**

## **PRODUCT DISPOSAL**

This projector utilizes tin-lead solder, and a pressurized lamp containing a small amount of mercury. Disposal of these materials may be regulated due to environmental considerations. For disposal or recycling information, please contact your local authorities or, if you are located in the United States of America, the Electronic Industries Alliance: [www.eiae.org](http://www.eiae.org).

## **Caution Concerning Lamp Replacement**

See "Replacing the Lamp" on page 50.

This EIKI projector uses a DMD panel. This very sophisticated panel contains 409,920 pixels (micromirrors). As with any high technology electronic equipment such as large screen TVs, video systems and video cameras, there are certain acceptable tolerances that the equipment must conform to.

This unit has some inactive pixels within acceptable tolerances which may result in inactive dots on the picture screen. This will not affect the picture quality or the life expectancy of the unit.

# How to Read this Owner's Manual

- The specifications are slightly different, depending on the model. However, you can connect and operate all models in the same manner.
- In this owner's manual, the illustration and the screen display are simplified for explanation, and may differ slightly from the actual display.

## Using the Menu Screen

• Press RETURN to return to the previous screen when the menu is displayed.

Buttons used in this operation

---

### Menu Selections (Adjustments)

**Example: Adjusting "Bright".**

- This operation can also be performed by using the buttons on the projector.

- 1** Press **MENU**.  
• The "Picture" menu screen for the selected input mode is displayed.
- 2** Press or and select "Picture" to adjust.

**Example: "Picture" screen menu for INPUT 1 (Component mode)**

Menu item		SEL	ADJ	END
Picture	SCR - ADJ	PRJ - ADJ	Help	
Picture Mode	0	Standard		
Contrast	0			
Bright	0			
Color	0			
Tint	0			
Sharp	0			
CLR Temp	75.00 K			
Bright Boost	1			
Progressive		3D Progressive		
Lamp Setting		Bright		
◆◆Reset		◆		
◆SEL/ADJ.		◆ENTER	◆END	

Button used in this step

On-screen display

39

**Info** .....Indicates safeguards for using the projector.

**Note** .....Indicates additional information for setting up and operating the projector.

## For Future Reference

Maintenance

➔ P. 47

Troubleshooting

➔ PP. 55 and 56

Index

➔ P. 59



# Contents

## Preparing

### Introduction

How to Read this Owner's Manual .....	3
Contents .....	4
<b>IMPORTANT SAFEGUARDS</b> .....	6
Accessories .....	10
Part Names and Functions .....	11
Inserting the Batteries .....	14
Usable Range .....	15

### Quick Start

Quick Start .....	16
-------------------	----

### Setup

Setting up the Projector .....	18
Setting up the Projector .....	18
Standard Setup (Front Projection) .....	18
Ceiling-mount Setup .....	18
Projection (PRJ) Mode .....	19
Screen Size and Projection Distance ..	20

### Connections

Samples of Cables for Connection .....	22
Connecting to Video Equipment .....	23
Connecting to a Computer .....	25
Connecting to a Monitor with RGB Input Terminal .....	26
Connecting to an Amplifier or Other Audio Equipment .....	27

## Using

### Basic Operation

Turning the Projector On/Off .....	28
Connecting the Power Cord .....	28
Turning the Projector on .....	28
Turning the Power off (Putting the Projector into Standby Mode) .....	29
Locking the Operation Buttons on the Projector (Keylock Function) .....	29
Image Projection .....	30
Switching the Input Mode .....	30
Adjusting the Projected Image .....	30
Adjusting the Volume .....	32
Displaying the Black Screen and Turning off the Sound Temporarily .....	32
Correcting Trapezoidal Distortion .....	33
Resize Mode .....	34

### Useful Features

Operating with the Remote Control ....	36
Freezing a Moving Image .....	36
Selecting the Picture Mode .....	36
Auto Sync (Auto Sync Adjustment) ....	36
Menu Items .....	37
Using the Menu Screen .....	39
Menu Selections (Adjustments) .....	39
Picture Adjustment ("Picture" menu) ..	41
Selecting the Picture Mode .....	41

Adjusting the Image .....	42
Adjusting the Color Temperature .....	42
Progressive .....	42
Lamp Setting .....	42
Adjusting the Projected Image ("SCR - ADJ" menu) .....	43
Setting the Resize Mode .....	43
Keystone Correction .....	43
Setting On-screen Display .....	43
Selecting the Background Image .....	43
Reversing/Inverting Projected Images .....	43
Selecting the On-screen Display Language .....	43
Adjusting the Projector Function ("PRJ - ADJ" menu) .....	44
Auto Search Function .....	44
Auto Sync (Auto Sync Adjustment) ....	44
Auto Power Off Function .....	45
Setting the Confirmation Sound (System Sound) .....	45
Speaker Setting .....	45
Fan Mode Setting .....	45
Checking the Lamp Life Status .....	45
Troubleshooting with "Help" menu .....	46
Utilizing "Help" menu functions .....	46

# Reference

## Appendix

---

Maintenance .....	47
Maintenance Indicators .....	48
Regarding the Lamp .....	50
Lamp .....	50
Caution Concerning the Lamp .....	50
Replacing the Lamp .....	50
Removing and Installing the Lamp Unit .....	51
Resetting the Lamp Timer .....	52

Connecting Pin Assignments .....	53
Computer Compatibility Chart .....	54
Troubleshooting .....	55
Specifications .....	57
Dimensions .....	58
Index .....	59



# IMPORTANT SAFEGUARDS

**CAUTION:** Please read all of these instructions before you operate this product and save these instructions for later use.

Electrical energy can perform many useful functions. This product has been engineered and manufactured to assure your personal safety. BUT IMPROPER USE CAN RESULT IN POTENTIAL ELECTRICAL SHOCK OR FIRE HAZARDS. In order not to defeat the safeguards incorporated in this product, observe the following basic rules for its installation, use and servicing.

## 1. Read Instructions

All the safety and operating instructions should be read before the product is operated.

## 2. Retain Instructions

The safety and operating instructions should be retained for future reference.

## 3. Heed Warnings

All warnings on the product and in the operating instructions should be adhered to.

## 4. Follow Instructions

All operating and use instructions should be followed.

## 5. Cleaning

Unplug this product from the wall outlet before cleaning. Do not use liquid cleaners or aerosol cleaners. Use a damp cloth for cleaning.

## 6. Attachments

Do not use attachments not recommended by the product manufacturer as they may cause hazards.

## 7. Water and Moisture

Do not use this product near water—for example, near a bath tub, wash bowl, kitchen sink, or laundry tub; in a wet basement; or near a swimming pool; and the like.

## 8. Accessories

Do not place this product on an unstable cart, stand, tripod, bracket, or table. The product may fall, causing serious injury to a child or adult, and serious damage to the product. Use only with a cart, stand, tripod, bracket, or table recommended by the manufacturer, or sold with the product. Any mounting of the product should follow the manufacturer's instructions, and should use a mounting accessory recommended by the manufacturer.

## 9. Transportation

A product and cart combination should be moved with care. Quick stops, excessive force, and uneven surfaces may cause the product and cart combination to overturn.



## 10. Ventilation

Slots and openings in the cabinet are provided for ventilation to ensure reliable operation of the product and to protect it from overheating, and these openings must not be blocked or covered. The openings should never be blocked by placing the product on a bed, sofa, rug, or other similar surface. This product should not be placed in a built-in installation such as a bookcase or rack unless proper ventilation is provided or the manufacturer's instructions have been adhered to.

## 11. Power Sources

This product should be operated only from the type of power source indicated on the marking label. If you are not sure of the type of power supply to your home, consult your product dealer or local power company. For products intended to operate from battery power, or other sources, refer to the operating instructions.

## 12. Grounding or Polarization

This product is provided with one of the following types of plugs. If the plug should fail to fit into the power outlet, please contact your electrician. Do not defeat the safety purpose of the plug.

- Two-wire type (mains) plug.
- Three-wire grounding type (mains) plug with a grounding terminal.  
This plug will only fit into a grounding type power outlet.

## 13. Power-Cord Protection

Power-supply cords should be routed so that they are not likely to be walked on or pinched by items placed upon or against them, paying particular attention to cords at plugs, convenience receptacles, and the point where they exit from the product.

## 14. Lightning

For added protection for this product during a lightning storm, or when it is left unattended and unused for long periods of time, unplug it from the wall outlet and disconnect the cable system. This will prevent damage to the product due to lightning and power-line surges.

### **15. Overloading**

Do not overload wall outlets, extension cords, or integral convenience receptacles as this can result in a risk of fire or electric shock.

### **16. Object and Liquid Entry**

Never push objects of any kind into this product through openings as they may touch dangerous voltage points or short-out parts that could result in a fire or electric shock. Never spill liquid of any kind on the product.

### **17. Servicing**

Do not attempt to service this product yourself as opening or removing covers may expose you to dangerous voltage or other hazards. Refer all servicing to qualified service personnel.

### **18. Damage Requiring Service**

Unplug this product from the wall outlet and refer servicing to qualified service personnel under the following conditions:

- a. When the power-supply cord or plug is damaged.
- b. If liquid has been spilled, or objects have fallen into the product.
- c. If the product has been exposed to rain or water.
- d. If the product does not operate normally by following the operating instructions. Adjust only those controls that are covered by the operating instructions, as an improper adjustment of other controls may result in damage and will often require extensive work by a qualified technician to restore the product to normal operation.
- e. If the product has been dropped or damaged in any way.
- f. When the product exhibits a distinct change in performance, this indicates a need for service.

### **19. Replacement Parts**

When replacement parts are required, be sure the service technician has used replacement parts specified by the manufacturer or have the same characteristics as the original part. Unauthorized substitutions may result in fire, electric shock, or other hazards.

### **20. Safety Check**

Upon completion of any service or repairs to this product, ask the service technician to perform safety checks to determine that the product is in proper operating condition.

### **21. Wall or Ceiling Mounting**

This product should be mounted to a wall or ceiling only as recommended by the manufacturer.

### **22. Heat**

This product should be situated away from heat sources such as radiators, heat registers, stoves, or other products (including amplifiers) that produce heat.

- DLP™ (Digital Light Processing) and DMD™ (Digital Micromirror Device) are trademarks of Texas Instruments, Inc.
- Microsoft® and Windows® are registered trademarks of Microsoft Corporation in the United States and/or other countries.
- PC/AT is a registered trademark of International Business Machines Corporation in the United States.
- Macintosh® is a registered trademark of Apple Computer, Inc. in the United States and/or other countries.
- All other company or product names are trademarks or registered trademarks of their respective companies.
- Some IC chips in this product include confidential and/or trade secret property belonging to Texas Instruments. Therefore you may not copy, modify, adapt, translate, distribute, reverse engineer, reverse assemble or discompile the contents thereof.

## Observe the following safeguards when setting up your projector.

### Caution concerning the lamp unit

- Potential hazard of glass particles if lamp ruptures. In case of lamp rupture, contact your nearest EIKI Authorized Dealer or Service Center for replacement. See “Replacing the Lamp” on page 50.

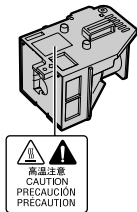

### Caution concerning the setup of the projector

- For minimal servicing and to maintain high image quality, EIKI recommends that this projector be installed in an area free from humidity, dust and cigarette smoke. When the projector is subjected to these environments, the vents and lens must be cleaned more often. As long as the projector is regularly cleaned, use in these environments will not reduce the overall operation life of the unit. Internal cleaning should only be performed by a EIKI Authorized Dealer or Service Center.

### Do not set up the projector in places exposed to direct sunlight or bright light.

- Position the screen so that it is not in direct sunlight or room light. Light falling directly on the screen washes out the colors, making viewing difficult. Close the curtains and dim the lights when setting up the screen in a sunny or bright room.

### Caution regarding placing of the projector

- Place the projector on a level site within the adjustment range (8 degrees) of the adjustment foot.

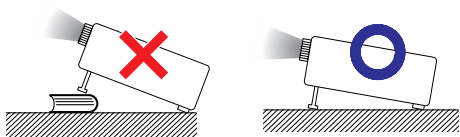

### When using the projector in high-altitude areas such as mountains (at altitudes of approximately 4,900 feet (1,500 meters) or more)

- When you use the projector in high-altitude areas with thin air, set “Fan Mode” to “High”. Neglecting this can affect the longevity of the optical system.

### Warning about placing the projector in a high position

- When placing the projector in a high position, ensure that it is secured carefully to avoid personal injury caused by the projector falling down.

### Do not subject the projector to hard impact and/or vibration.

- Protect the lens so as not to hit or damage the surface of the lens.

### Rest your eyes occasionally.

- Continuously watching the screen for long hours will cause eye strain. Be sure to occasionally rest your eyes.

### Avoid locations with extremes of temperature.

- The operating temperature of the projector is from 41°F to 95°F (+5°C to +35°C).
- The storage temperature of the projector is from -4°F to 140°F (-20°C to +60°C).

### Do not block the exhaust and intake vents.

- Allow at least 11 <sup>13</sup>/<sub>16</sub> inches (30 cm) of space between the exhaust vent and the nearest wall or obstruction.
- Be sure that the intake vent and the exhaust vent are not obstructed.
- If the cooling fan becomes obstructed, a protection circuit will automatically put the projector into standby mode to prevent overheat damage. This does not indicate a malfunction. (See pages 48 and 49.) Remove the projector power cord from the wall outlet and wait at least 10 minutes. Place the projector where the intake and exhaust vents are not blocked, plug the power cord back in and turn on the projector. This will return the projector to the normal operating condition.

- When turning off the projector, the cooling fan runs to decrease the internal temperature for a while. Unplug the power cord after the cooling fan stops. The period the cooling fan runs will vary, depending on the circumstances and the internal temperature.

### Caution regarding usage of the projector

- When using the projector, be sure not to subject it to hard impact and/or vibration, as this can result in damage. Take extra care with the lens. Before moving the projector, be sure to unplug the power cord from the wall outlet, and disconnect any other cables connected to it.
- Do not carry the projector by holding the lens.
- When storing the projector, re-attach the lens cap. (See page 11).
- Do not expose the projector to direct sunlight or place next to heat sources. Doing so may affect the cabinet color or cause deformation of the plastic cover.

### Other connected equipment

- When connecting a computer or other audio-visual equipment to the projector, make the connections AFTER unplugging the power cord of the projector from the AC outlet and turning off the equipment to be connected.
- Please read the owner's manuals of the projector and the equipment to be connected for instructions on how to make the connections.

### Using the projector in other countries

- The power supply voltage and the shape of the plug may vary depending on the region or country you are using the projector in. When using the projector overseas, be sure to use an appropriate power cord for the country you are in.

### Temperature monitor function



- If the projector starts to overheat due to setup problems or blockage of the air vents, the crossed-out 'X' icon and "TEMP." will illuminate in the lower left corner of the picture. If the temperature continues to rise, the lamp will turn off, the temperature warning indicator on the projector will blink, and after a 90-second cooling-off period the projector will enter standby mode. Refer to "Maintenance Indicators" on page 48 for details.

### Info

- The cooling fan regulates the internal temperature, and its performance is automatically controlled. The sound of the fan may change during projector operation due to changes in the fan speed. This does not indicate malfunction.
- Do not unplug the power cord during projection or cooling fan operation. This can cause damage due to rise in internal temperature, as the cooling fan also stops.

# Accessories

## Supplied accessories



Remote control



Two R-6 batteries  
("AA" size, UM/SUM-3,  
HP-7 or similar)

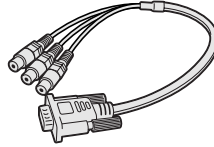

3 RCA to 15-pin  
D-sub adaptor  
(11.8" (30 cm))  
QCNWGA075WJPZ

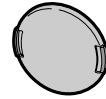

Lens cap (attached)

Power cord\*  
(1)

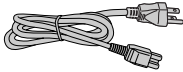

For U.S. and  
Canada, etc.  
(6' (1.8 m))  
QACCDAA007WJPZ

(2)

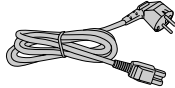

For Europe,  
except U.K.  
(6' (1.8 m))  
QACCVAA011WJPZ

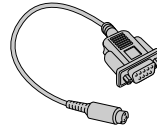

DIN-D-sub  
RS-232C adaptor  
(5 <sup>57</sup>/<sub>64</sub>" (15 cm))  
QCNWGA015WJPZ

- Owner's manual  
(this manual)

\* Use the power cord that corresponds to the wall outlet in your country.

## Optional accessory

■ Lamp unit

AH-11201

# Part Names and Function

Numbers in **■** refer to the main pages in this owner's manual where the topic is explained.

## Projector

### Top View

Power indicator **28, 48**

STANDBY-ON button **28**

For turning the power on and putting the projector into standby mode.

ENTER button **39**

For setting items selected or adjusted on the menu.

KEYSTONE button **33**

For entering the Keystone Correction mode.

**28, 48** Lamp indicator

**48** Temperature warning indicator

**32** Volume buttons (-◀/▶+)  
For adjusting the speaker sound level.

**30** INPUT buttons (▲/▼)  
For switching input mode 1, 2, 3 or 4.

**39, 46** MENU/HELP button  
For displaying adjustment and setting screens, and help screen.

**39** Adjustment buttons (▲/▼/◀/▶)  
For selecting menu items.

### Front View

Focus ring **30**

For adjusting the focus.

HEIGHT ADJUST lever **31**

**47** Intake vent

**30** Zoom ring  
For enlarging/reducing the picture.

**15** Remote control sensor

Push both sides of the lens cap to attach or remove.

# Part Names and Functions (Continued)

Numbers in **■** refer to the main pages in this owner's manual where the topic is explained.

## Rear View

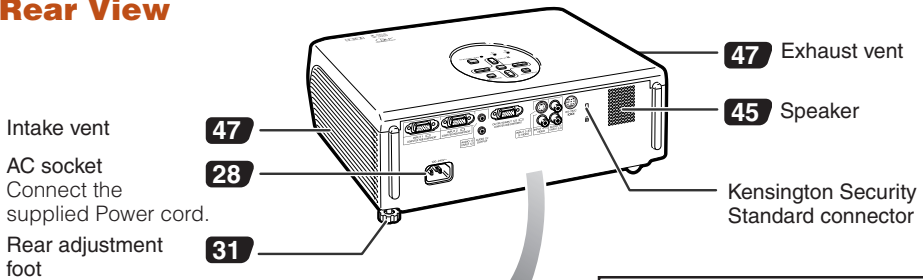

### Terminals

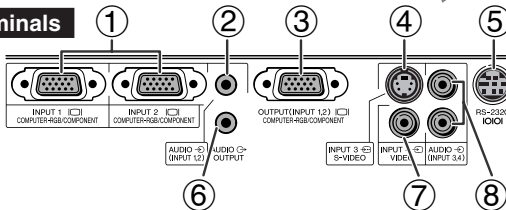

### Using the Kensington Lock

- This projector has a Kensington Security Standard connector for use with a Kensington MicroSaver Security System. Refer to the information that came with the system for instructions on how to use it to secure the projector.

Terminal	Description	Page
①	INPUT 1, 2 terminal ■ Connecting video equipment with component output terminal (DVD player, DTV decoder, DVD recorder with hard disc, etc.).	<b>23</b>
	■ Connecting the computer.	<b>25</b>
②	AUDIO (INPUT 1, 2) terminal Connecting an audio cable (Shared audio input terminal for INPUT 1 and 2).	<b>23</b> <b>25</b>
③	OUTPUT (INPUT 1, 2) terminal Connecting the monitor when you want to simultaneously watch the projection image on the monitor. (Shared computer RGB and component signals output terminal for INPUT 1 and 2).	<b>26</b>
④	INPUT 3 terminal Connecting video equipment with S-video output terminal (VCR, DVD player, etc.).	<b>24</b>
⑤	RS-232C terminal Serviceman only Use the DIN-D-sub RS-232C adaptor (supplied) to connect to the RS-232C port of the computer.	-
⑥	AUDIO OUTPUT terminal Connecting to an amplifier or other audio equipment with an audio cable (commercially available) (Shared audio output terminal for INPUT 1, 2, 3 and 4).	<b>27</b>
⑦	INPUT 4 terminal Connecting video equipment without S-video output terminal.	<b>24</b>
⑧	AUDIO (INPUT 3, 4) terminal Connecting an audio cable (Shared audio input terminal for INPUT 3 and 4).	<b>24</b>

Numbers in **■** refer to the main pages in this owner's manual where the topic is explained.

**STANDBY button**  
For putting the projector into the standby mode.

**KEystone button**  
For entering the Keystone Correction mode.

**RETURN button**  
For returning to the previous menu screen during menu operations.

**AV MUTE button**  
For temporarily displaying the black screen and turning off the sound.

**PICTURE MODE button**  
For selecting the appropriate picture.

**29**

**33**

**39**

**32**

**36**

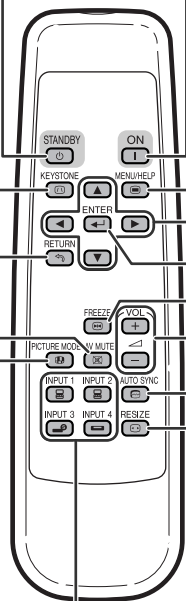

**28**

**ON button**  
For turning the power on.

**39**

**MENU/HELP button**  
For displaying adjustment and setting screens, and help screen.

**46**

**39**

**Adjustment buttons (▲/▼/◀/▶)**  
• For selecting menu items.  
• For adjusting the Keystone Correction when in the Keystone Correction mode.

**39**

**ENTER button**  
For setting items selected or adjusted on the menu.

**36**

**FREEZE button**  
For freezing images.

**32**

**Volume buttons**  
For adjusting the speaker sound level.

**36**

**AUTO SYNC button**  
For automatically adjusting images when connected to a computer.

**34**

**RESIZE button**  
For switching the screen size (STRETCH, SIDE BAR, CINEMA ZOOM).

**30**

**INPUT 1, 2, 3 and 4 buttons**  
For switching to the respective input modes.



# Part Names and Functions (Continued)

## Inserting the Batteries

- 1** Press the ▲ mark on the cover and slide it in the direction of the arrow.

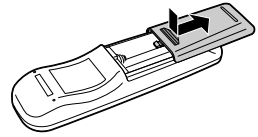

- 2** Insert the batteries.
  - Insert the batteries making sure the polarities correctly match the ⊕ and ⊖ marks inside the battery compartment.

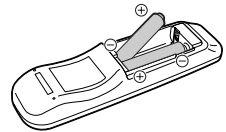

- 3** Attach the cover and slide it until it clicks into place.

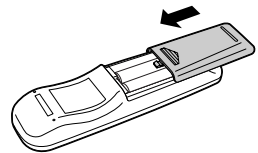

**Incorrect use of the batteries may cause them to leak or explode. Please follow the precautions below.**



### Caution

- Danger of explosion if battery is incorrectly replaced. Replace only with the same or equivalent type.
  - Insert the batteries making sure the polarities correctly match the ⊕ and ⊖ marks inside the battery compartment.
  - Batteries of different types have different properties, therefore do not mix batteries of different types.
  - Do not mix new and old batteries.  
This may shorten the life of new batteries or may cause old batteries to leak.
  - Remove the batteries from the remote control once they have run out, as leaving them in can cause them to leak.  
Battery fluid from leaked batteries is harmful to skin, therefore ensure that you first wipe them and then remove them using a cloth.
- 
- The batteries included with this projector may run down in a short period, depending on how they are kept. Be sure to replace them as soon as possible with new batteries.
  - Remove the batteries from the remote control if you will not be using the remote control for a long time.
  - Comply with the rules (ordinance) of each local government when disposing of worn-out batteries.

## Usable Range

The remote control can be used to control the projector within the ranges shown in the illustration.

### Note

- The signal from the remote control can be reflected off a screen for easy operation. However, the effective distance of the signal may differ depending on the screen material.

### When using the remote control

- Ensure that you do not drop, expose to moisture or high temperature.
- The remote control may malfunction under a fluorescent lamp. In this case, move the projector away from the fluorescent lamp.

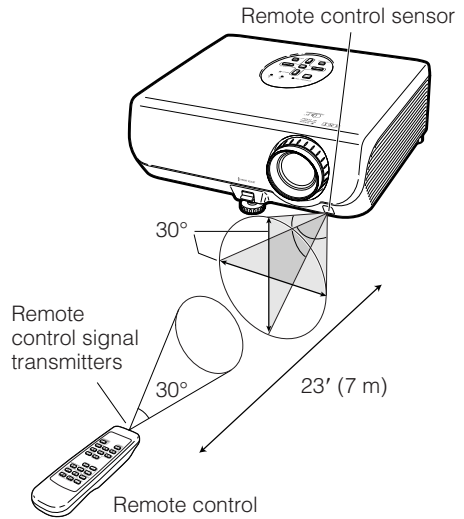

# Quick Start

This section shows the basic operation (projector connecting with the video equipment). For details, see the page described below for each step.

## Setup and Projection

In this section, connection of the projector and the video equipment is explained using one example.

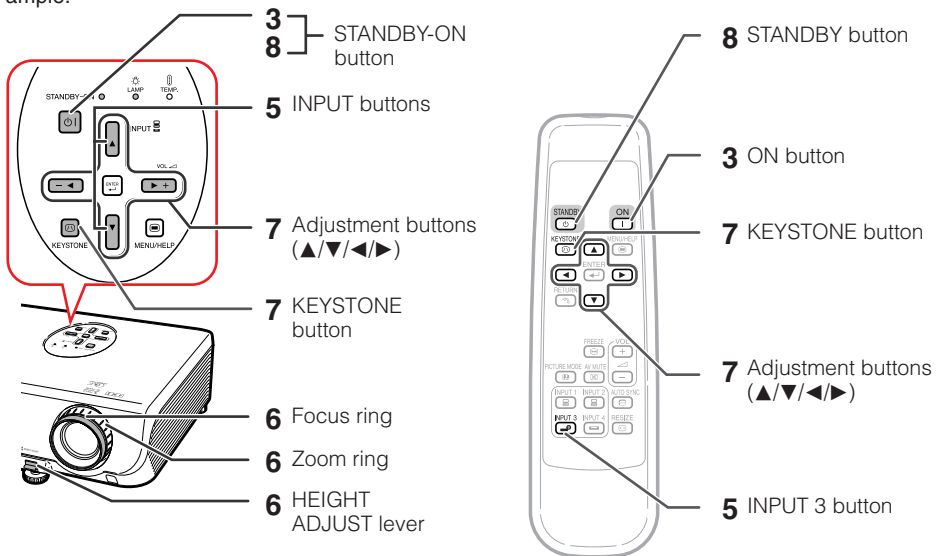

**1. Place the projector facing a wall or a screen** → P. 18

**2. Connect the projector to the video equipment and plug the power cord into the AC socket of the projector**

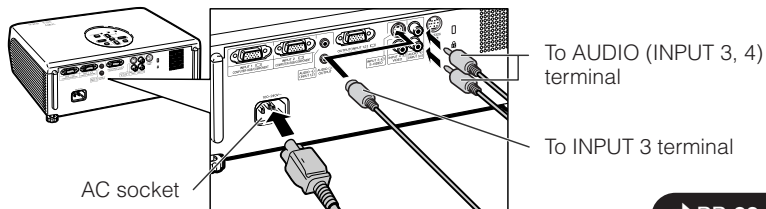

→ PP. 22–28

**3. Remove the lens cap and turn the projector on**

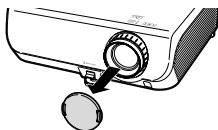

On the projector



On the remote control



→ P. 28

## 4. Turn the video equipment on and start playback

## 5. Select the INPUT mode

Select the "INPUT 3" using the INPUT button on the projector or  INPUT 3 on the remote control.



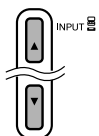

On the projector

On-screen display

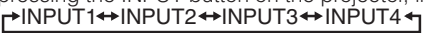

On the remote control



- When pressing the INPUT button on the projector, input mode switches in the following order: 
- When using the remote control, press the  INPUT 1/ INPUT 2/ INPUT 3/ INPUT 4 button to switch the INPUT mode.

→ P. 30

## 6. Adjust the focus, image size, and projector angle

1. Adjust the focus by turning the focus ring.

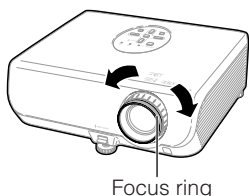

Focus ring

2. Adjust the projection image size by turning the zoom ring.

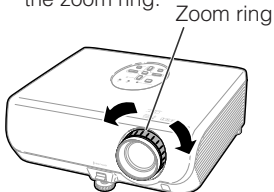

Zoom ring

3. Adjust the projector angle using the HEIGHT ADJUST lever.

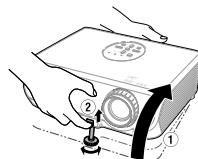

→ PP. 30, 31

## 7. Correct trapezoidal distortion

Correcting trapezoidal distortion using the Keystone Correction.

On the projector

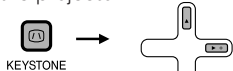

On the remote control

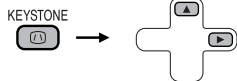

Shrinks upper side.



Shrinks lower side.

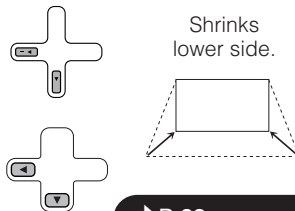

→ P. 33

## 8. Turn the Power off

Press the STANDBY-ON button on the projector or the STANDBY button on the remote control, and then press the button again while the confirmation message is displayed, to put the projector into standby mode.

On the projector



On the remote control



On-screen Display

 Enter STANDBY mode?

Yes : Press Again

No : Please Wait

- Unplug the power cord from the AC outlet after the cooling fan stops.

→ P. 29

# Setting up the Projector

## Setting up the Projector

For optimal image quality, position the projector perpendicular to the screen with the projector's feet flat and level. Doing so will eliminate the need for Keystone correction and provide the best image quality. (See page 33.)

### Standard Setup (Front Projection)

- Place the projector at the required distance from the screen according to the desired picture size. (See page 20.)

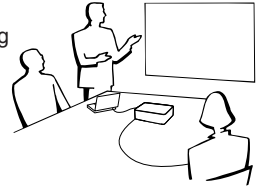

### Example of standard setup

#### Side View

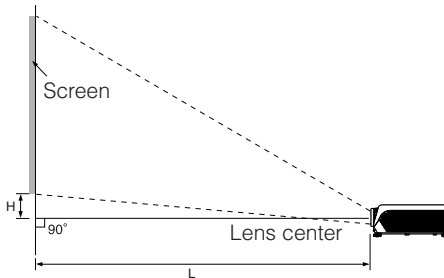

#### Note

- Refer to page 20 for additional information concerning "Screen Size and Projection Distance".

### Ceiling-mount Setup

- It is recommended that you use the optional EIKI ceiling-mount bracket for this installation. Before mounting the projector, contact your nearest EIKI Authorized Dealer or Service Center to obtain the recommended ceiling-mount bracket (sold separately).
- Invert the image by setting "Ceiling + Front" in "PRJ Mode". See page 43 for use of this function.

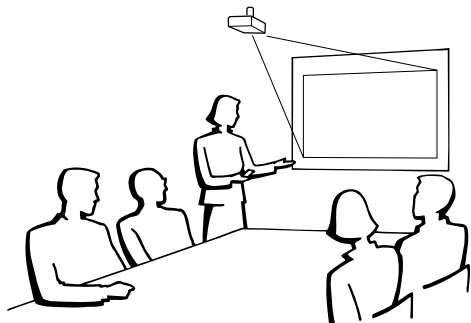

## Projection (PRJ) Mode

The projector can use any of the 4 projection modes, shown in the diagram below. Select the mode most appropriate for the projection setting in use. (You can set the PRJ mode in "SCR-ADJ" menu. See page 43.)

■ Table mounted, front projection

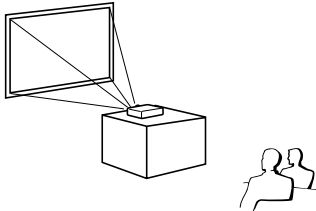

■ Ceiling mounted, front projection

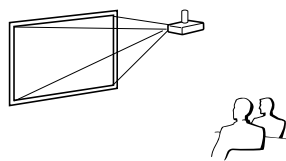

Menu item → "Front"

■ Table mounted, rear projection (with a translucent screen)

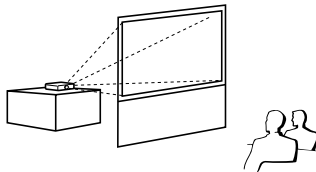

Menu item → "Ceiling + Front"

■ Ceiling mounted, rear projection (with a translucent screen)

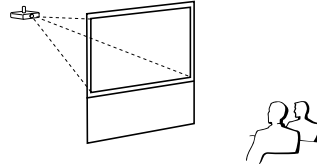

Menu item → "Rear"

Menu item → "Ceiling + Rear"

### Indication of the Projection Image Size and Projection Distance

Example: STRETCH Mode (16:9)

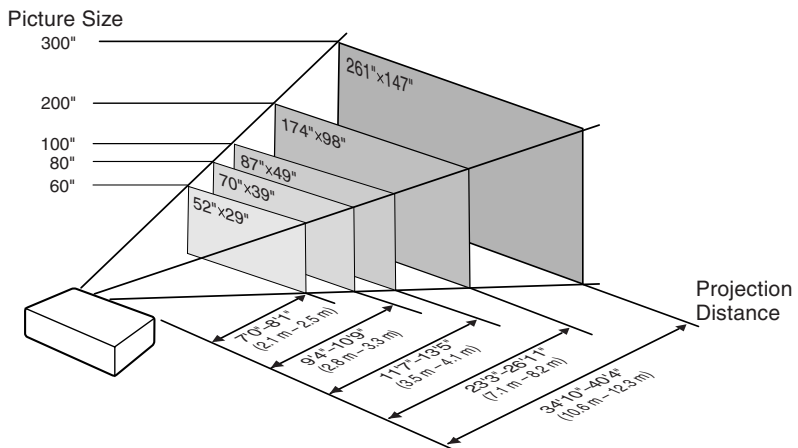

# Setting up the Projector (Continued)

## Screen Size and Projection Distance

When using a wide screen (16:9) and projecting 16:9 image

Picture (Screen) size			Projection distance [L]		Distance from the lens center to the bottom of the image [H]
Diag. [χ]	Width	Height	Minimum [L1]	Maximum [L2]	
300" (762 cm)	261" (664 cm)	147" (374 cm)	34' 10" (10.6 m)	40' 4" (12.3 m)	-38 <sup>3</sup> / <sub>32</sub> " (-97 cm)
270" (686 cm)	235" (598 cm)	132" (336 cm)	31' 4" (9.6 m)	36' 4" (11.1 m)	-34 <sup>9</sup> / <sub>32</sub> " (-87 cm)
250" (635 cm)	218" (553 cm)	123" (311 cm)	29' 1" (8.9 m)	33' 7" (10.2 m)	-31 <sup>47</sup> / <sub>64</sub> " (-81 cm)
200" (508 cm)	174" (443 cm)	98" (249 cm)	23' 3" (7.1 m)	26' 11" (8.2 m)	-25 <sup>25</sup> / <sub>64</sub> " (-64 cm)
150" (381 cm)	131" (332 cm)	74" (187 cm)	17' 5" (5.3 m)	20' 2" (6.1 m)	-19 <sup>3</sup> / <sub>64</sub> " (-48 cm)
100" (254 cm)	87" (221 cm)	49" (125 cm)	11' 7" (3.5 m)	13' 5" (4.1 m)	-12 <sup>45</sup> / <sub>64</sub> " (-32 cm)
80" (203 cm)	70" (177 cm)	39" (100 cm)	9' 4" (2.8 m)	10' 9" (3.3 m)	-10 <sup>5</sup> / <sub>32</sub> " (-26 cm)
70" (178 cm)	61" (155 cm)	34" (87 cm)	8' 2" (2.5 m)	9' 5" (2.9 m)	-8 <sup>57</sup> / <sub>64</sub> " (-23 cm)
60" (152 cm)	52" (133 cm)	29" (75 cm)	7' 0" (2.1 m)	8' 1" (2.5 m)	-7 <sup>5</sup> / <sub>8</sub> " (-19 cm)
40" (102 cm)	35" (89 cm)	20" (50 cm)	4' 8" (1.4 m)	5' 5" (1.6 m)	-5 <sup>5</sup> / <sub>64</sub> " (-13 cm)

χ: Picture size (diag.) (in/cm)

L: Projection distance (ft/m)

L1: Minimum projection distance (ft/m)

L2: Maximum projection distance (ft/m)

H: Distance from the lens center to the bottom of the image (in/cm)

The formula for picture size and projection distance

**[Feet/inches]**

L1 (ft) = 0.03541χ / 0.3048

L2 (ft) = 0.04098χ / 0.3048

H (in) = -0.32249χ / 2.54

**[m/cm]**

L1 (m) = 0.03541χ

L2 (m) = 0.04098χ

H (cm) = -0.32249χ

When using a normal screen (4:3) and projecting 4:3 image (SIDE BAR Mode)

Picture (Screen) size			Projection distance [L]		Distance from the lens center to the bottom of the image [H]
Diag. [χ]	Width	Height	Minimum [L1]	Maximum [L2]	
300" (762 cm)	240" (610 cm)	180" (457 cm)	42' 8" (13.0 m)	49' 4" (15.0 m)	-46 <sup>39</sup> / <sub>64</sub> " (-118 cm)
270" (686 cm)	216" (549 cm)	162" (411 cm)	38' 5" (11.7 m)	44' 5" (13.5 m)	-41 <sup>61</sup> / <sub>64</sub> " (-107 cm)
250" (635 cm)	200" (508 cm)	150" (381 cm)	35' 7" (10.8 m)	41' 2" (12.5 m)	-38 <sup>27</sup> / <sub>32</sub> " (-99 cm)
200" (508 cm)	160" (406 cm)	120" (305 cm)	28' 5" (8.7 m)	32' 11" (10.0 m)	-31 <sup>5</sup> / <sub>64</sub> " (-79 cm)
150" (381 cm)	120" (305 cm)	90" (229 cm)	21' 4" (6.5 m)	24' 8" (7.5 m)	-23 <sup>5</sup> / <sub>16</sub> " (-59 cm)
100" (254 cm)	80" (203 cm)	60" (152 cm)	14' 3" (4.3 m)	16' 5" (5.0 m)	-15 <sup>17</sup> / <sub>32</sub> " (-39 cm)
80" (203 cm)	64" (163 cm)	48" (122 cm)	11' 5" (3.5 m)	13' 2" (4.0 m)	-12 <sup>7</sup> / <sub>16</sub> " (-32 cm)
70" (178 cm)	56" (142 cm)	42" (107 cm)	9' 11" (3.0 m)	11' 6" (3.5 m)	-10 <sup>7</sup> / <sub>8</sub> " (-28 cm)
60" (152 cm)	48" (122 cm)	36" (91 cm)	8' 6" (2.6 m)	9' 10" (3.0 m)	-9 <sup>21</sup> / <sub>64</sub> " (-24 cm)
40" (102 cm)	32" (81 cm)	24" (61 cm)	5' 8" (1.7 m)	6' 7" (2.0 m)	-6 <sup>7</sup> / <sub>32</sub> " (-16 cm)

χ: Picture size (diag.) (in/cm)

L: Projection distance (ft/m)

L1: Minimum projection distance (ft/m)

L2: Maximum projection distance (ft/m)

H: Distance from the lens center to the bottom of the image (in/cm)

The formula for picture size and projection distance

**[Feet/inches]**

L1 (ft) = 0.04334χ / 0.3048

L2 (ft) = 0.05015χ / 0.3048

H (in) = -0.39468χ / 2.54

**[m/cm]**

L1 (m) = 0.04334χ

L2 (m) = 0.05015χ

H (cm) = -0.39468χ

## When using a normal screen (4:3) and projecting 16:9 image

Picture (Screen) size			Projection distance [L]		Distance from the lens center to the bottom of the image [H]
Diag. [ $\chi$ ]	Width	Height	Minimum [L1]	Maximum [L2]	
300" (762 cm)	240" (610 cm)	180" (457 cm)	32' 0" (9.8 m)	37' 0" (11.3 m)	-34 <sup>31</sup> / <sub>32</sub> " (-89 cm)
270" (686 cm)	216" (549 cm)	162" (411 cm)	28' 9" (8.8 m)	33' 4" (10.2 m)	-31 <sup>15</sup> / <sub>32</sub> " (-80 cm)
250" (635 cm)	200" (508 cm)	150" (381 cm)	26' 8" (8.1 m)	30' 10" (9.4 m)	-29 <sup>9</sup> / <sub>64</sub> " (-74 cm)
200" (508 cm)	160" (406 cm)	120" (305 cm)	21' 4" (6.5 m)	24' 8" (7.5 m)	-23 <sup>5</sup> / <sub>16</sub> " (-59 cm)
150" (381 cm)	120" (305 cm)	90" (229 cm)	16' 0" (4.9 m)	18' 6" (5.6 m)	-17 <sup>31</sup> / <sub>64</sub> " (-44 cm)
100" (254 cm)	80" (203 cm)	60" (152 cm)	10' 8" (3.3 m)	12' 4" (3.8 m)	-11 <sup>21</sup> / <sub>32</sub> " (-30 cm)
80" (203 cm)	64" (163 cm)	48" (122 cm)	8' 6" (2.6 m)	9' 10" (3.0 m)	-9 <sup>21</sup> / <sub>64</sub> " (-24 cm)
70" (178 cm)	56" (142 cm)	42" (107 cm)	7' 6" (2.3 m)	8' 8" (2.6 m)	-8 <sup>5</sup> / <sub>32</sub> " (-21 cm)
60" (152 cm)	48" (122 cm)	36" (91 cm)	6' 5" (2.0 m)	7' 5" (2.3 m)	-7" (-18 cm)
40" (102 cm)	32" (81 cm)	24" (61 cm)	4' 3" (1.3 m)	4' 11" (1.5 m)	-4 <sup>21</sup> / <sub>32</sub> " (-12 cm)

$\chi$ : Picture size (diag.) (in/cm)

L: Projection distance (ft/m)

L1: Minimum projection distance (ft/m)

L2: Maximum projection distance (ft/m)

H: Distance from the lens center to the bottom of the image (in/cm)

The formula for picture size and projection distance

**[Feet/inches]**

L1 (ft) = 0.0325 $\chi$  / 0.3048

L2 (ft) = 0.03761 $\chi$  / 0.3048

H (in) = - 0.29601 $\chi$  / 2.54

**[m/cm]**

L1 (m) = 0.0325 $\chi$

L2 (m) = 0.03761 $\chi$

H (cm) = - 0.29601 $\chi$















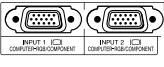
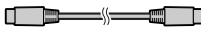

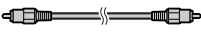

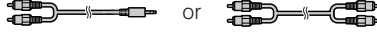
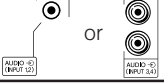
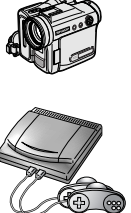
### Note

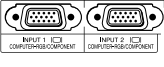
- Refer to page **18** concerning "Projection distance [L]" and "Distance from the lens center to the bottom of the image [H]".
- There are some errors in the values in the diagrams above.
- Values with a minus (-) sign indicate the distance from the lens center below the bottom of the image.

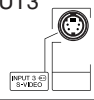
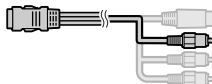

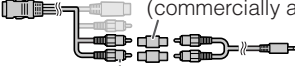
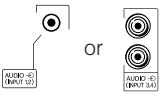
# Samples of Cables for Connection

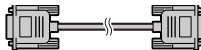
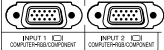
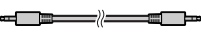
- For more details of connection and cables, refer to the owner's manual of the connecting equipment.
- You may need other cables or connectors not listed below.

Equipment	Input Signal	Cable	Terminal on the projector
<b>Audio-visual equipment</b> 	<b>Component video</b>	Component cable (commercially available)  3 RCA to 15-pin D-sub adaptor (supplied)	<b>INPUT1, 2</b> 
	<b>S-video</b>	S-video cable (commercially available) 	<b>INPUT3</b> 
	<b>Video</b>	Video cable (commercially available) 	<b>INPUT4</b> 
	<b>Audio</b>	ø3.5 mm minijack to RCA audio cable (commercially available) 	<b>AUDIO INPUT</b> 
<b>Camera/ video game</b> 	<b>Component video</b>	Cables for a camera or a video game  3 RCA to 15-pin D-sub adaptor (supplied)	<b>INPUT1, 2</b> 
	<b>S-video</b>	Cables for a camera or a video game 	<b>INPUT3</b> 
	<b>Video</b>	Cables for a camera or a video game 	<b>INPUT4</b> 
	<b>Audio</b>	Cables for a camera or a video game/ø3.5 mm minijack to RCA audio cable (commercially available) RCA adaptor plug (commercially available)  or connect directly to AUDIO (INPUT 3, 4).	<b>AUDIO INPUT</b> 
<b>Computer</b> 	<b>RGB video</b>	RGB cable (commercially available) 	<b>INPUT1, 2</b> 
	<b>Computer audio</b>	ø3.5 mm stereo audio cable (commercially available) 	<b>AUDIO INPUT</b> 

# Connecting to Video Equipment

**Before connecting, ensure that the power cord of the projector is unplugged from the AC outlet and turn off the devices to be connected. After making all connections, turn on the projector first and then the other devices.**

The projector is equipped with input terminals that support component, S-video, and video signals. See the illustration below to connect with the audio-visual equipment.

The image quality is highest in the order of the component signal, the S-video signal and the video signal. If your audio-visual equipment has a component output terminal, use the COMPUTER/COMPONENT terminal (INPUT1 or INPUT 2) on the projector for video connection.

**When connecting to equipment with component output terminal (INPUT1 or INPUT2)**

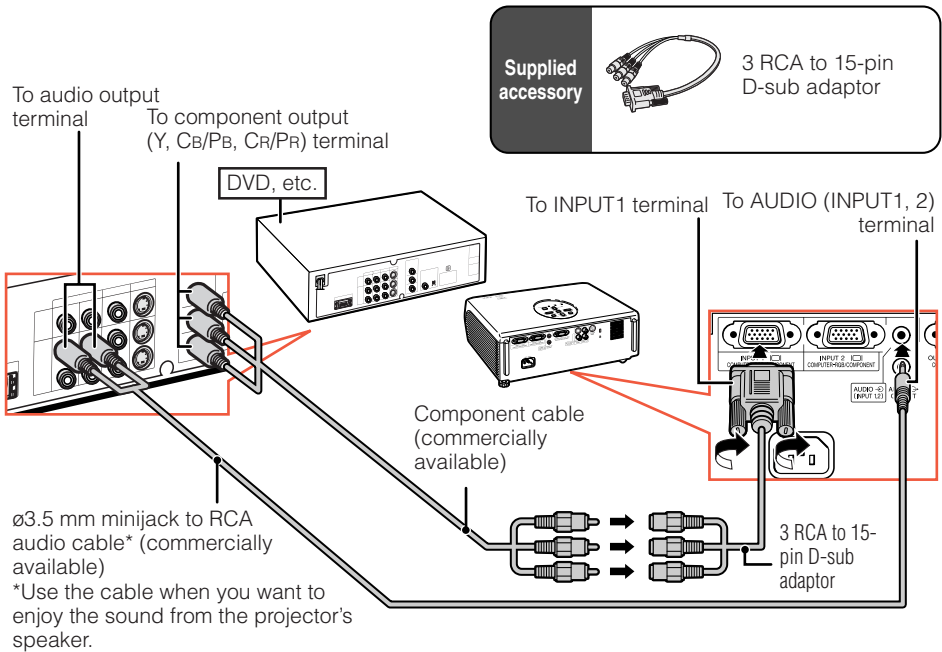

# Connecting to Video Equipment (Continued)

## When connecting to equipment with S-video output terminal (INPUT3)

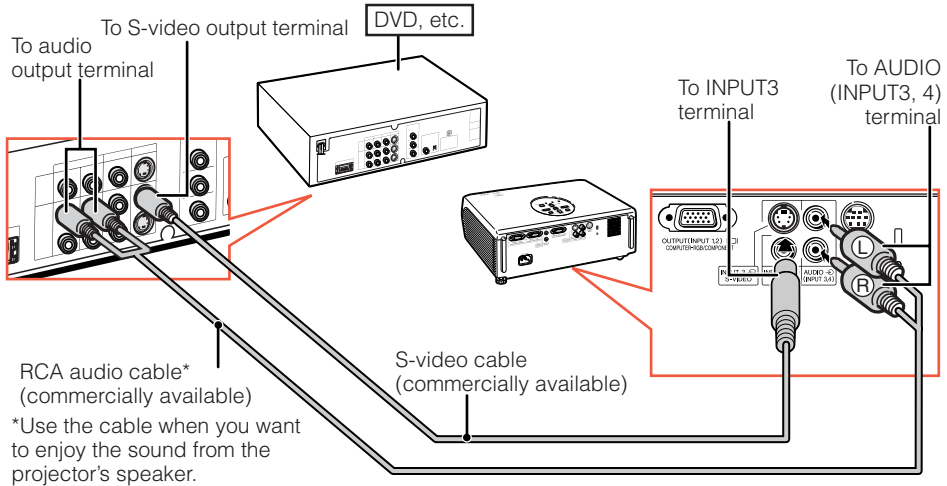

## When connecting to equipment with video output terminal (INPUT4)

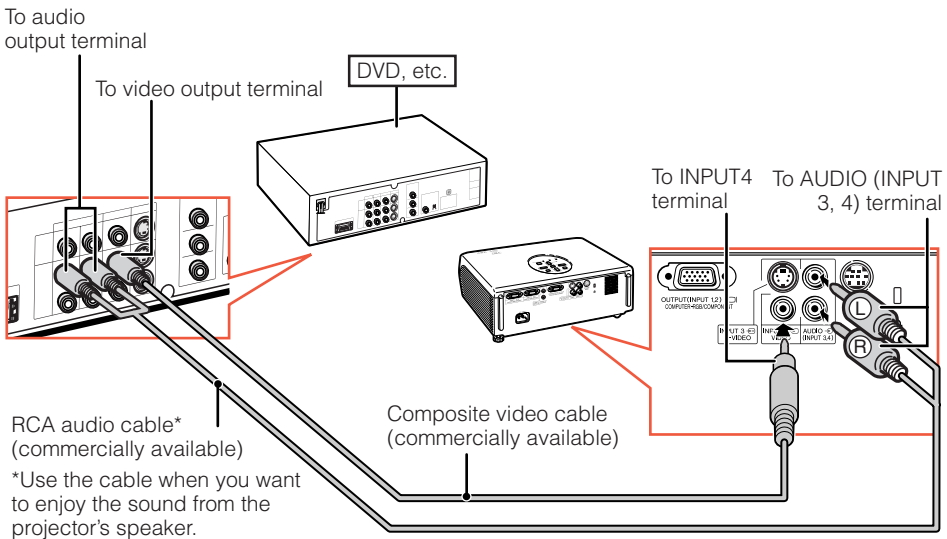

# Connecting to a Computer

**When connecting a computer, ensure that it is the last device to be turned on after all the connections are made.**

Ensure that you have read the owner's manuals of the devices to be connected before making connections.

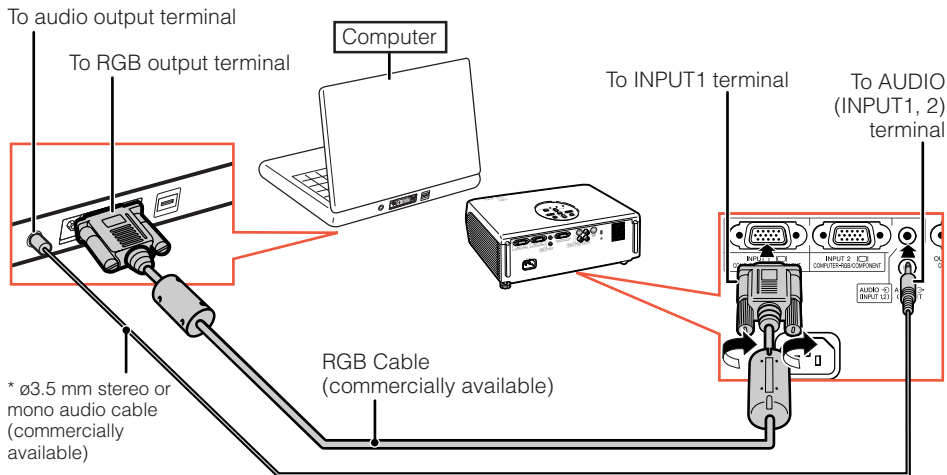

\* When using the ø3.5 mm mono audio cable, the volume level will be half of when using the ø3.5 mm stereo audio cable.

## Note

- See page 54 "Computer Compatibility Chart" for a list of computer signals compatible with the projector. Use with computer signals other than those listed may cause some of the functions to not work.
- A Macintosh adaptor may be required for use with some Macintosh computers. Contact your nearest Macintosh Dealer.
- **Depending on the computer you are using, an image may not be projected unless the computer's external output port is switched on.** Refer to the specific instructions in the owner's manual of your computer to enable your computer's external output port.

# Connecting to a Monitor with RGB Input Terminal

You can display computer images on both the projector and a separate monitor using two sets of RGB cables.

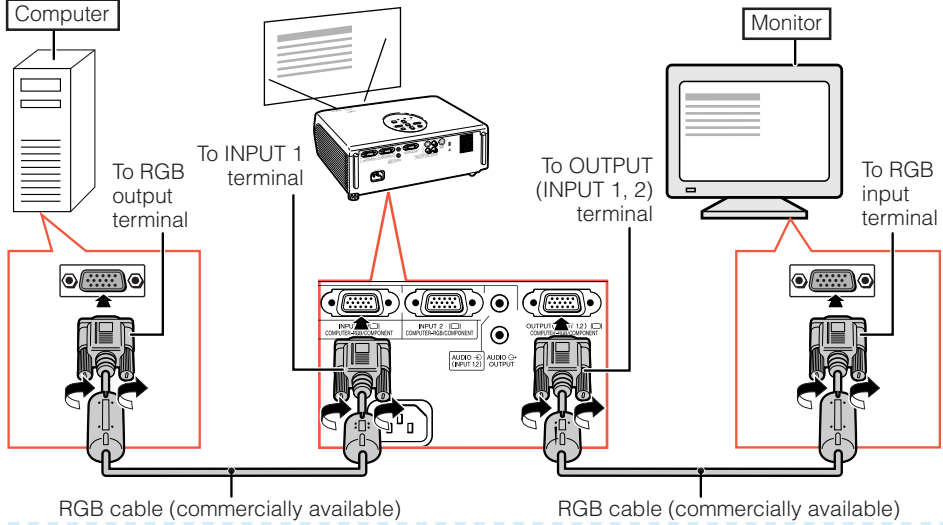

## Note

- RGB signals and Component signals can be output to the monitor.

# Connecting to an Amplifier or Other Audio Equipment

The audio input from devices connected to the AUDIO INPUT terminals on the projector can be output to audio equipment. The audio output is determined according to the selected input mode.

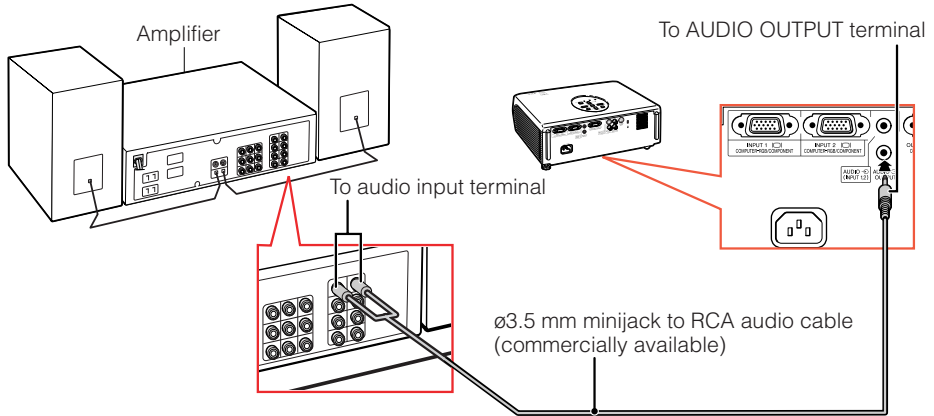

## Note

- ø3.5 mm minijack to RCA audio cable (commercially available) is required.
- Before connecting, ensure that both the projector and the audio equipment to be connected are turned off.
- When turning off the projector while it is connected to audio equipment, ensure that you turn off the audio equipment first and then the projector.
- The volume level of external equipment changes in accordance with the volume level of the projector.

# Turning the Projector On/Off

## Connecting the Power Cord

Plug the supplied power cord into the AC socket on the rear of the projector.

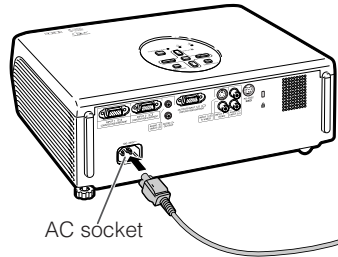
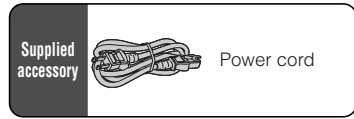

## Turning the Projector on

Note that the connections to external equipment and power outlet should be done before performing the operations written below. (See pages 23 to 28.)

Remove the lens cap and press **STANDBY-ON** on the projector or **ON** on the remote control.

**Info**

- English is the factory default language. If you want to change the on-screen display to another language, change the language according to the procedure on page 43.

### Note

#### About the Lamp Indicator

The lamp indicator illuminates to indicate the status of the lamp.

**Red:** The lamp is on.



**Blinking in red:** The lamp is warming up or shutting down.

**Green:** The lamp is shut down abnormally or the lamp should be replaced.

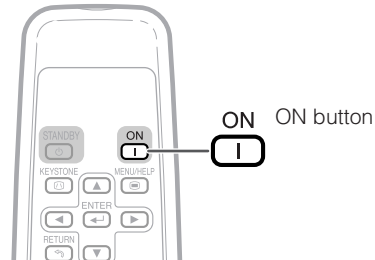
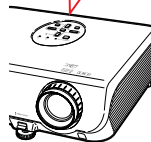
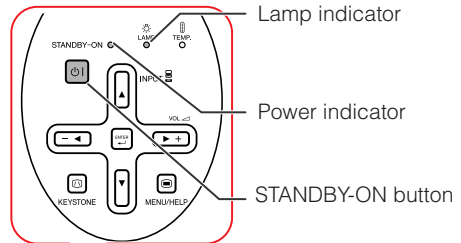
- When switching on the projector, a slight flickering of the image may be experienced within the first minute after the lamp has been illuminated. This is normal operation as the lamp's control circuitry is stabilising the lamp output characteristics. It should not be regarded as faulty operation.
- If the projector is put into standby mode and immediately turned on again, the lamp may take some time to start projection.



## Turning the Power off (Putting the Projector into Standby Mode)

**1** Press  STANDBY-ON on the projector or  STANDBY on the remote control, then press that button again while the confirmation message is displayed, to put the projector into standby mode.

**2** Unplug the power cord from the AC outlet after the cooling fan stops.

- The power indicator on the projector blinks in red while cooling.
- The power indicator changes to green when the projector finishes cooling.

### Info

- Do not unplug the power cord during projection or cooling fan operation. This can cause damage due to rise in internal temperature, as the cooling fan also stops.

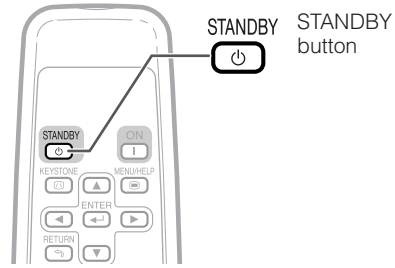

On-screen Display (confirmation message)

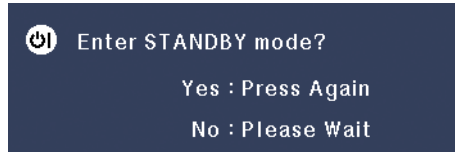

Shutting Down. Please Wait.

## Locking the Operation Buttons on the Projector (Keylock Function)

Use this function to lock the operation buttons on the projector.



### ■ Locking the Operation Buttons

Hold down  ENTER on the projector for about 5 seconds while the projector is being turned on.

- The keylock function does not affect the operation with the remote control buttons.
- You cannot use the keylock function while the projector is warming up.

### ■ Taking the Keylock off

Hold down  ENTER on the projector for about 5 seconds.

- When the projector is in standby mode, you can release the keylock by holding down  ENTER and  STANDBY-ON on the projector simultaneously for about 5 seconds.

### Info

- Keylock does not function while the projector is: displaying "Menu" screens, in standby mode, warming up, changing input signals, operating "Auto Sync" function, or in "Freeze" mode.

▼ On-screen Display

Keylock function ON

▼ On-screen Display

Keylock function OFF



# Image Projection

## Switching the Input Mode

Select the appropriate input mode for the connected equipment.

Press **INPUT 1**, **INPUT 2**, **INPUT 3** or **INPUT 4** on the remote control to select the input mode.

- When pressing INPUT (**▲/▼**) on the projector, input mode switches in the following order:  
**INPUT1 ↔ INPUT2 ↔ INPUT3 ↔ INPUT4**
- When "Auto Search" is set to "On", INPUT (**▲/▼**) on the projector functions as the Auto Search buttons. (See page 44.)

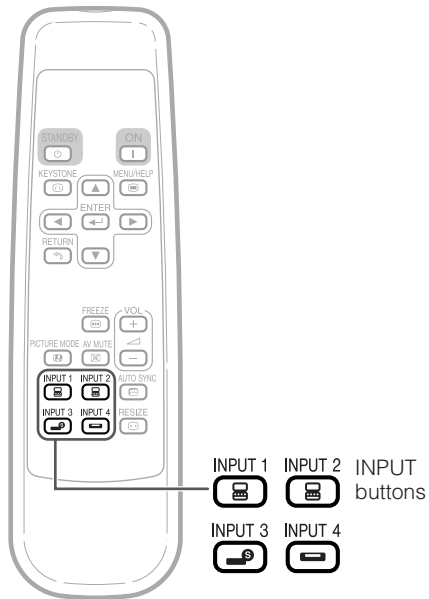

## Adjusting the Projected Image

### 1 Adjusting the Focus

You can adjust the focus with the focus ring on the projector.

Rotate the focus ring to adjust the focus while watching the projected image.

### 2 Adjusting the Screen Size

You can adjust the screen size using the zoom ring on the projector.

Rotate the zoom ring to enlarge or shrink the screen size.

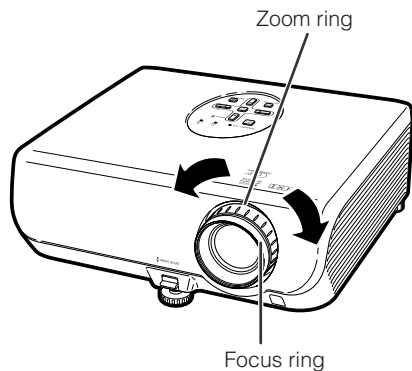

### 3 Adjusting the Height

The height of the projector can be adjusted using the adjustment feet at the front and rear of the projector.

When the screen is above the projector, the projection image can be made higher by adjusting the projector.

**1** Lift the projector to adjust its height while lifting the HEIGHT ADJUST lever.

**2** Remove your hands from the HEIGHT ADJUST lever of the projector after its height has been finely adjusted.

- The angle of projection is adjustable up to 8 degrees from the surface on which the projector is placed.

**3** Use the rear adjustment foot to make the projector level.

- The projector is adjustable  $\pm 1$  degree from the standard position.



#### Note

- When adjusting the height of the projector, trapezoidal distortion occurs. Follow the procedures in Keystone Correction to correct the distortion. (See pages 33 and 43.)



#### Info

- Do not apply too much pressure on the projector when the front adjustment foot comes out.
- When lowering the projector, be careful not to get your fingers caught in the area between the adjustment foot and the projector.
- Hold the projector firmly while lifting or carrying.
- Do not hold by the lens area.

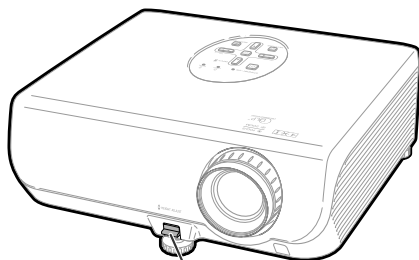

HEIGHT ADJUST lever

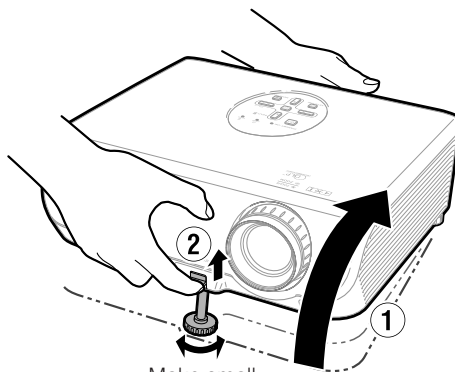

Make small adjustments.

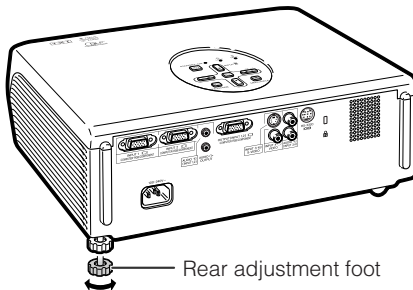

Rear adjustment foot

# Image Projection (Continued)

## Adjusting the Volume

Press **[-]/[+]** on the remote control or **-</>+>** on the projector to adjust the volume.

### Note

- Pressing **[-]/<** will lower the volume.
- Pressing **[+]/>** will raise the volume.
- When the projector is connected to external equipment, the volume level of the external equipment changes in accordance with the volume level of the projector. Set the projector's volume to the lowest level when turning the projector on/off or changing the input signal.
- When you do not want to output the sound from the projector's speaker while the projector is connected to external equipment, set "Speaker" in "PRJ-ADJ" menu to "Off". (See page 45.)

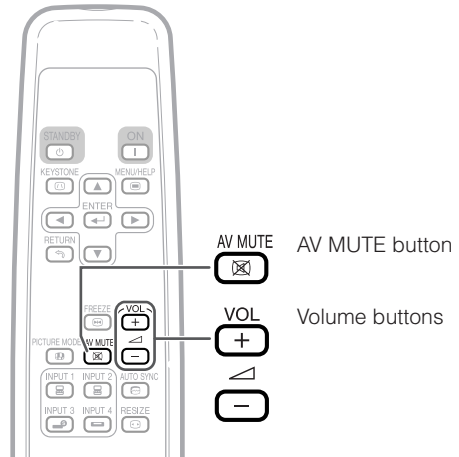

On-screen Display



## Displaying the Black Screen and Turning off the Sound Temporarily

Press **[X] AV MUTE** on the remote control to temporarily display a black screen and turn off the sound.

### Note

- Pressing **[X] AV MUTE** again will turn the projected image back on.

On-screen Display



## Correcting Trapezoidal Distortion

When the image is projected either from the top or from the bottom towards the screen at an angle, the image becomes distorted trapezoidally. The function for correcting trapezoidal distortion is called **Keystone Correction**.

### Note

- The Keystone Correction can be adjusted up to an angle of approximately  $\pm 13$  degrees and the screen can also be set up to an angle of approximately  $\pm 13$  degrees (when the resize mode is set to "STRETCH" (see page 34)).

### 1 Press **KEYSTONE** to enter the Keystone Correction mode.

- You can also display the on-screen display of the Keystone Correction mode with **KEYSTONE** on the projector.

### 2 Press **▲/▶** or **◀/▼** to adjust the Keystone Correction.

- You can also adjust the Keystone Correction using the adjustment buttons on the projector.

### Note

- Press **RETURN** while the on-screen display of the Keystone Correction mode is on the screen to return to the default setting.

### 3 Press **KEYSTONE**.

- The on-screen display of the Keystone Correction mode will disappear.
- You can also use **KEYSTONE** on the projector.

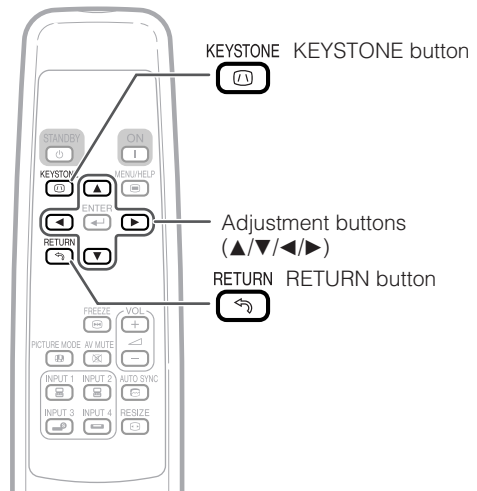

### ▼ On-screen display (Keystone Correction mode)



Shrinks upper side.  
(Move the slide bar in the + direction.)

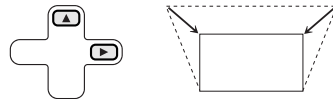

Shrinks lower side.  
(Move the slide bar in the - direction.)

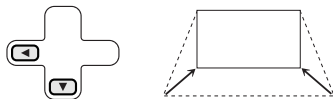

### Info

- While adjusting the image using Keystone Correction, straight lines and the edges of the image may appear jagged.

# Image Projection (Continued)

## Resize Mode

This function allows you to modify or customize the resize mode to enhance the input image. Depending on the input signal, you can choose “STRETCH”, “SIDE BAR” or “CINEMA ZOOM” image.

Press **RESIZE**.

- See page 43 for setting on menu screen.

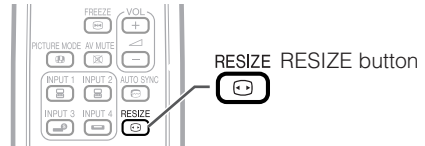

### VIDEO



- “STRETCH” is fixed when 540P, 720P or 1080I signals are entered.

Input Signal		Output screen image		
DVD / Video	Image type	STRETCH	SIDE BAR	CINEMA ZOOM
480I, 480P, 576I, 576P, NTSC, PAL, SECAM	<p>4:3 aspect ratio</p>			
	<p>Letter box</p>			
	<p>Squeezed</p>			
	<p>16:9 aspect ratio</p>			
540P, 720P, 1080I	<p>16:9 aspect ratio</p>		—	—

: Cutout area on which images cannot be projected.

## Computer

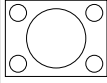
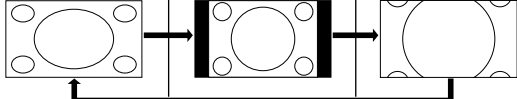
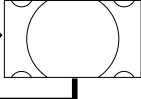
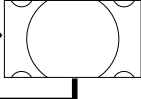
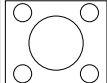
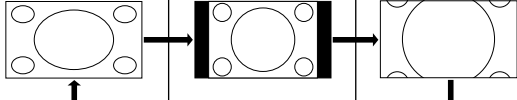
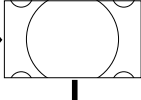
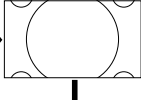
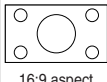
		STRETCH	SIDE BAR
4:3 aspect ratio	SVGA (800 × 600)	854 × 480	640 × 480
	XGA (1024 × 768)		
	SXGA (1280 × 960)		
	SXGA + (1400 × 1050)		
Other aspect ratios	SXGA (1280 × 1024)	854 × 480	640 × 480
	1280 × 720	854 × 480	—

Input Signal		Output screen image		
Computer	Image type	STRETCH	SIDE BAR	CINEMA ZOOM
Resolution lower than SVGA				
SVGA	 4:3 aspect ratio			
Resolution higher than SVGA				
SXGA (1280 × 1024)	 5:4 aspect ratio			
1280 × 720	 16:9 aspect ratio		—	—

 : Cutout area on which images cannot be projected.

# Operating with the Remote Control

## Freezing a Moving Image

- 1 Press **[FREEZE]** **FREEZE**.
  - The projected image is frozen.
- 2 Press **[FREEZE]** **FREEZE** again to return to the moving image from the currently connected device.

## Selecting the Picture Mode

You can select the appropriate picture mode to best match the projected image you are watching.

- Press **[PICTURE MODE]** **PICTURE MODE**.
- When pressing **[PICTURE MODE]** **PICTURE MODE**, the picture mode changes in the following order:  
→Standard→Natural→Dynamic→Movie1→Movie2→

### Note

- See page 41 for details on the picture mode.

## Auto Sync (Auto Sync Adjustment)

Auto Sync function works when detecting input signal after the projector turns on.

Press **[AUTO SYNC]** **AUTO SYNC** to manually adjust with Auto Sync function.

### Note

- When the optimum image cannot be achieved with Auto Sync adjustment, use the help menu for manual adjustments. (See page 46.)

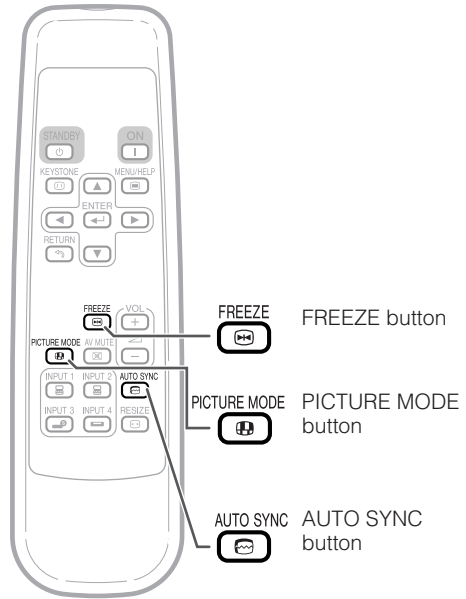

# Menu Items

The following shows the items that can be set in the projector.

## “Picture” menu

INPUT 1 (Component)/INPUT 2 (Component)/INPUT 3/INPUT 4

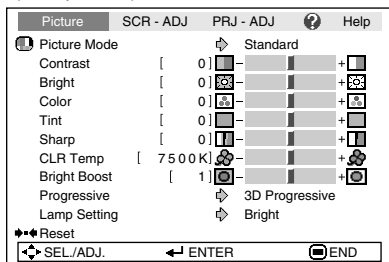

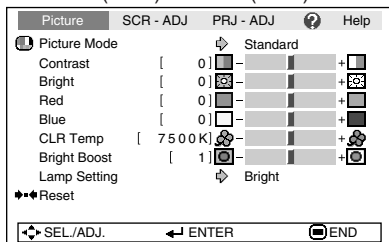

INPUT 1 (RGB)/INPUT 2 (RGB)

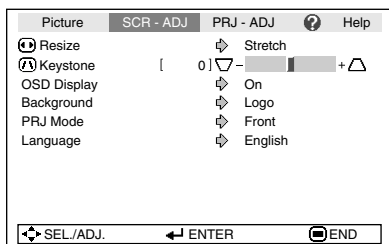

## “Screen adjustment (SCR-ADJ)” menu



- You can adjust the menu items with icons (  ,  , and  ) using the respective buttons on the remote control.

\*1 Items when inputting component signal through INPUT 1 or INPUT 2, or when selecting INPUT 3 or INPUT 4.

\*2 “Tone” will appear on the menu screen only when PAL or SECAM signals are input (including when forcibly changed to those input signals). There is basically no need to adjust “Tone”, but you can adjust the picture tone with this adjustment when inputting PAL or SECAM signals.

\*3 Items when inputting RGB signal through INPUT 1 or INPUT 2.

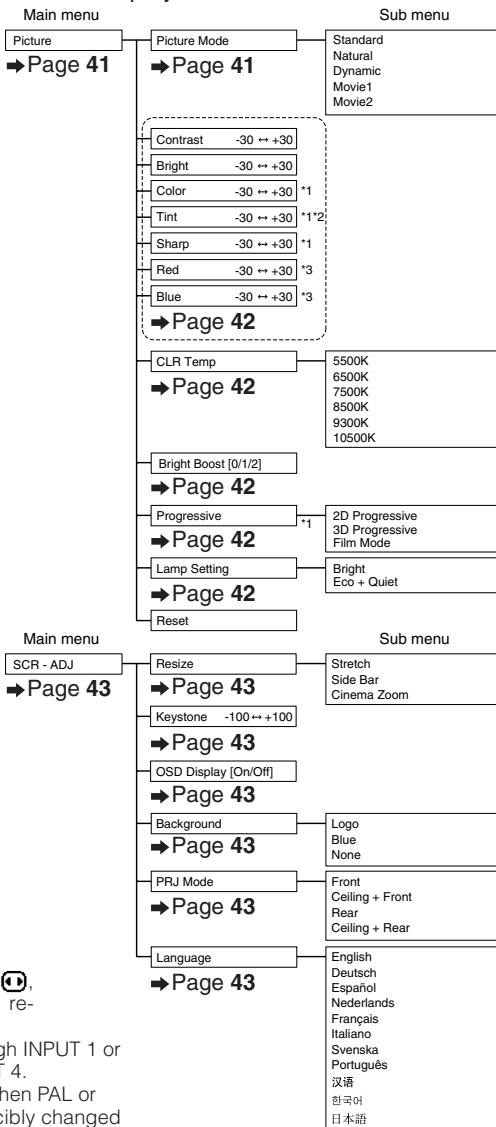



# Menu Items (Continued)

## “Projection adjustment (PRJ-ADJ)” menu

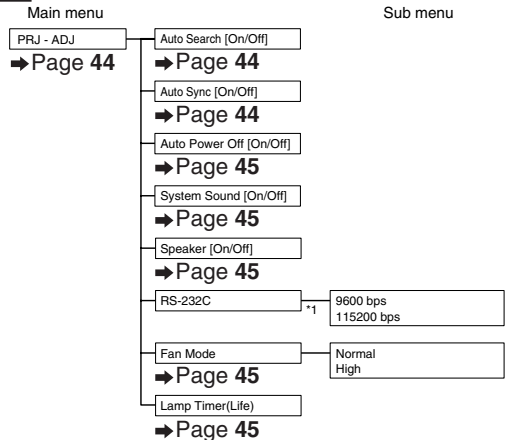
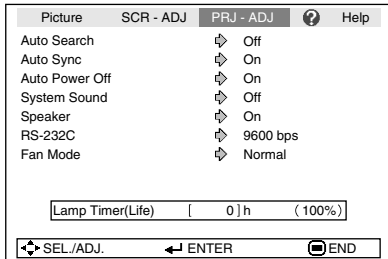

\*1 Serviceman only

## “Help” menu

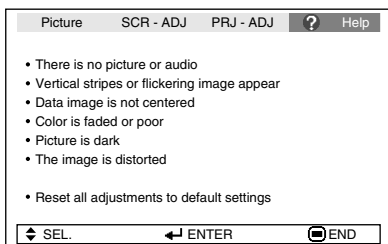

## The items you can set with “Help” menu

“Help” menu ➔ Page 46

- Vertical stripes or flickering image appear
  - Auto Sync
  - Adjust vertical noise
  - Adjust horizontal noise
- Data image is not centered
  - Auto Sync
  - H-Pos
  - V-Pos
- Color is faded or poor
  - INPUT 1 or INPUT 2
  - Signal type: Auto/RGB/Component
  - INPUT 3 or INPUT 4
  - Video System: A u t o / P A L / S E C A M / NTSC4.43/NTSC3.58/PAL-M/PAL-N/PAL-60

\* The selectable items vary depending on the input signal and the selected input mode.

# Using the Menu Screen

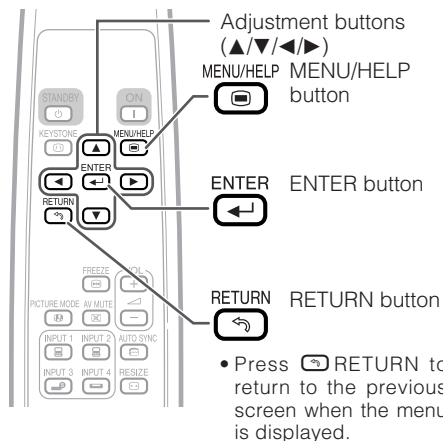
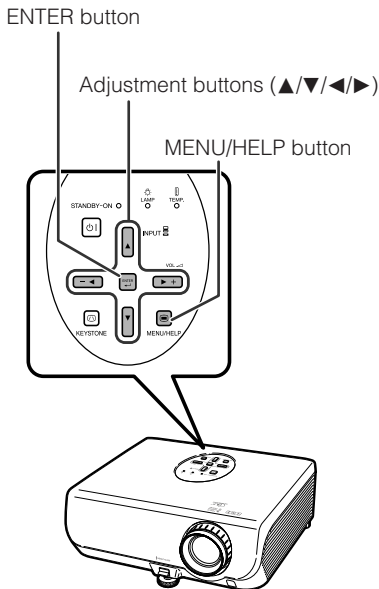

## Menu Selections (Adjustments)

Example: Adjusting “Bright”.

- This operation can also be performed by using the buttons on the projector.

**1** Press MENU.

- The “Picture” menu screen for the selected input mode is displayed.

**2** Press or and select “Picture” to adjust.

Example: “Picture” screen menu for INPUT 1 (Component) mode

Menu item

Picture	SCR - ADJ	PRJ - ADJ	Help
Picture Mode		Standard	
Contrast	[ 0 ]		
Bright	[ 0 ]		
Color	[ 0 ]		
Tint	[ 0 ]		
Sharp	[ 0 ]		
CLR Temp	[ 7500K ]		
Bright Boost	[ 1 ]		
Progressive		3D Progressive	
Lamp Setting		Bright	
◆◆◆ Reset			
◆◆◆ SEL./ADJ.		← ENTER	END

# Using the Menu Screen (Continued)

## 3 Press ▲ or ▼ and select “Bright” to adjust.

- The selected item is highlighted.

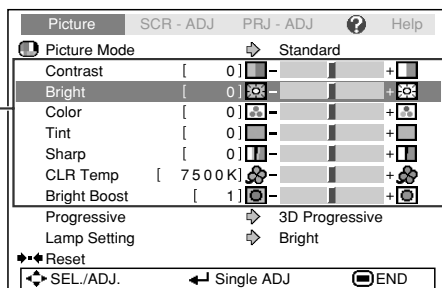

Items to be adjusted

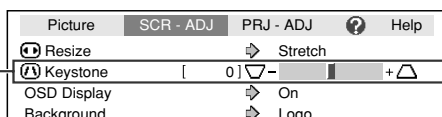

## To adjust the projected image while watching it Press ENTER.

- The selected item (e.g. “Bright”) is displayed by itself at the bottom of the screen.
- When pressing ▲ or ▼, the following item (“Color” after “Bright”) will be displayed.

The item displayed by itself



### Note

- Press ENTER again to return to the previous screen.

## 4 Press ◀ or ▶ to adjust the item selected.

- The adjustment is stored.

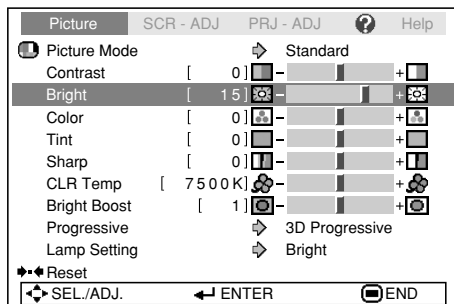

## 5 Press MENU/HELP.

- The menu screen will disappear.

### Note

- Menu buttons do not function while the projector is operating the “Auto Sync”, “FREEZE”, or “AV MUTE” functions.

# Picture Adjustment (“Picture” menu)

Menu operation → Page 39

▶ Example: “Picture” screen menu for INPUT 3 mode

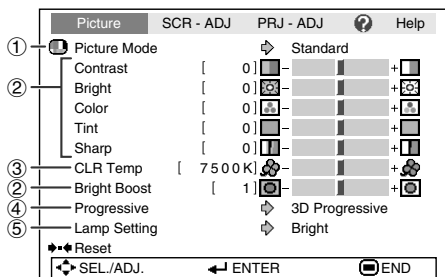

▶ Example: “Picture” screen menu for INPUT 1 (RGB) mode

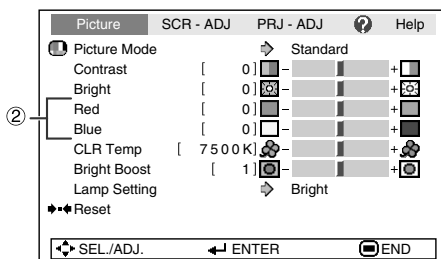

## 1 Selecting the Picture Mode

Selectable items	Description	The default settings of each item when selecting Picture Mode		
		CLR Temp	Bright Boost	Lamp Setting
Standard	For standard image	7500K	1	Bright
Natural	A balanced color image is obtained.	7500K	0	Bright
Dynamic	A vivid image is obtained.	7500K	2	Bright
Movie1	Gives greater depth to darker portions of images.	6500K	0	Eco + Quiet
Movie2	Brightness is toned down and the image becomes more balanced.	6500K	0	Eco + Quiet

- You can set or adjust each item in the “Picture” menu to your preference. Any changes you make are retained in memory.

### Note

- You can also press PICTURE MODE on the remote control to select the picture mode. (See page 36.)

# Picture Adjustment (“Picture” menu) (Continued)

Menu operation → Page 39

## ② Adjusting the Image

Adjustment Items	◀ button	▶ button
Contrast	For less contrast.	For more contrast.
Bright	For less brightness.	For more brightness.
Color*1	For less color intensity.	For more color intensity.
Tint*1 *2	For making skin tones purplish.	For making skin tones greenish.
Sharp*1	For less sharpness.	For more sharpness.
Red	For weaker red.	For stronger red.
Blue	For weaker blue.	For stronger blue.
Bright Boost	For high fidelity color reproduction.	For more vividness.

\*1 Not displayed in the RGB input mode.

\*2 “Tone” will appear on the menu screen only when PAL or SECAM signals are input (including when forcibly changed to those input signals). There is basically no need to adjust “Tone”, but you can adjust the picture tone with this adjustment when inputting PAL or SECAM signals.

### Note

- To reset all adjustment items, select “Reset” and press ENTER.

## ③ Adjusting the Color Temperature

Selectable items	Description
5500K 6500K 7500K 8500K 9300K 10500K	For lower color temperature for warmer, reddish incandescent-like images.  For higher color temperature for cooler, bluish, fluorescent-like images.

### Note

- Values on “CLR Temp” are only for general standard purposes.

## ④ Progressive

Selectable items	Description
2D Progressive	Useful to display fast-moving images such as sports.
3D Progressive	Useful to display relatively slow-moving images such as drama and documentary more clearly.
Film Mode	Reproduces the image of film source* clearly. Displays the optimized image of film transformed with three-two pull down (NTSC and PAL60Hz) or two-two pull down (PAL50Hz and SECAM) enhancement to progressive mode images.

\* The film source is a digital video recording with the original encoded as is at 24 frames/second. The projector can convert this film source to progressive video at 60 frames/second with NTSC and PAL60Hz or at 50 frames/second with PAL50Hz and SECAM to play back a high-definition image.

### Note

- In NTSC or PAL60Hz, even if the 3D Progressive mode has been set, the three-two pull down enhancement will be enabled automatically when the film source has been entered.
- When the image is blurred or noisy, switch to the optimal mode.
- When using progressive inputs, inputs are directly displayed so that 2D Progressive, 3D Progressive and Film Mode cannot be selected.

## ⑤ Lamp Setting

Selectable items	Brightness	Fan sound	Power consumption (When using AC 100V)	Lamp Life
Eco + Quiet	Approx. 87%	Low	305W	Approx. 3,000 hours
Bright	100%	Normal	350W	Approx. 2,000 hours

### Note

- When “Lamp Setting” is set to “Eco+Quiet”, the power consumption will decrease and the lamp life will extend. (Projection brightness decreases approximately 13%.)

# Adjusting the Projected Image ("SCR - ADJ" menu)

Menu operation → Page 39

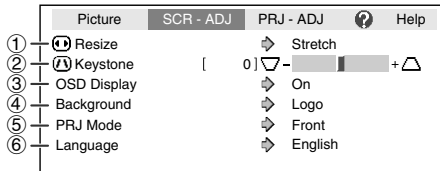

## ① Setting the Resize Mode

### Note

- For details of the Resize mode, see pages 34 and 35.
- You can also press RESIZE on the remote control to set the resize mode. (See page 34.)

## ② Keystone Correction

When the image is projected either from the top or from the bottom towards the screen at an angle, the image becomes distorted trapezoidally. The function for correcting trapezoidal distortion is called Keystone Correction.

Select "Keystone" on the "SCR-ADJ" menu and adjust with the slide bar.

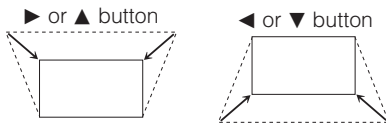

See page 33 for details of Keystone Correction.

### Note

- The Keystone Correction can be adjusted up to an angle of approximately  $\pm 13$  degrees (when "Resize" is set to "Stretch").

## ③ Setting On-screen Display

Selectable items	Description
On	All On-screen Displays are displayed.
Off	INPUT/VOLUME/AV MUTE/FREEZE/AUTO SYNC/RESIZE/PICTURE MODE/"An invalid button has been pressed." are not displayed.

## ④ Selecting the Background Image

Selectable items	Description
Logo	EIKI logo screen
Blue	Blue screen
None	—

## ⑤ Reversing/Inverting Projected Images

Selectable items	Description
Front	Normal image (Projected from the front of the screen)
Ceiling + Front	Inverted image (Projected from the front of the screen with an inverted projector)
Rear	Reversed image (Projected from the rear of the screen or with a mirror)
Ceiling + Rear	Reversed and inverted image (Projected with a mirror)

See page 19 for details of Projection (PRJ) Mode.

## ⑥ Selecting the On-screen Display Language

The projector can switch the on-screen display language among 11 languages.

English	Svenska
Deutsch	Português
Español	汉语
Nederlands	한국어
Français	日本語
Italiano	

# Adjusting the Projector Function (“PRJ - ADJ” menu)

Menu operation → Page 39

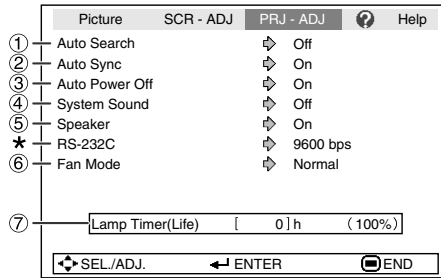

★Serviceman only

## ① Auto Search Function

This function automatically searches for and switches to the input mode in which signals are being received, when the projector is turned on, or when the INPUT button is pressed.

### Note

#### When “Auto Search” is set to “On”

- If two or more input signals are found, the projector selects the input source in the order of INPUT 1 → INPUT 2 → INPUT 3 → INPUT 4 when you press INPUT (▲/▼) on the projector.
- While “Auto Search” is set to “On”, press INPUT 1, INPUT 2, INPUT 3 or INPUT 4 on the remote control to select an input mode other than the input mode selected by the projector.

## ② Auto Sync (Auto Sync Adjustment)

Selectable items	Description
On	Auto Sync adjustment will occur when the projector is turned on or when the input signals are switched, when connected to a computer.
Off	Auto Sync adjustment is not automatically performed.

### Note

- Auto Sync adjustment is also performed by pressing AUTO SYNC on the remote control.
- The Auto Sync adjustment may take some time to complete, depending on the image of the computer connected to the projector.
- When the optimum image cannot be achieved with Auto Sync adjustment, use manual adjustments. (See page 46.)

### ③ Auto Power Off Function

Selectable items	Description
On	When no input signal is detected for more than 15 minutes, the projector will automatically enter standby mode.
Off	The Auto Power Off function will be disabled.

#### Note

- When the Auto Power Off function is set to "On", 5 minutes before the projector enters standby mode, the message "Enter STANDBY mode in X min." will appear on the screen to indicate the remaining minutes.

### ④ Setting the Confirmation Sound (System Sound)

Selectable items	Description
On	A confirmation sound is made when the projector turns on/off.
Off	No confirmation sound is made.

### ⑤ Speaker Setting

Selectable items	Description
On	The audio signal is output from the internal speaker.
Off	The audio signal is not output from the internal speaker.

### ⑥ Fan Mode Setting

This function changes the fan rotation speed.

Selectable items	Description
Normal	Suitable for normal environments.
High	Select this when using the projector at altitudes of approximately 4,900 feet (1,500 meters) or more.

When "Fan Mode" is set to "High", the fan rotation speeds up, and the fan noise becomes louder.

### ⑦ Checking the Lamp Life Status

You can confirm the cumulative lamp usage time and the remaining lamp life (percentage).

Lamp usage condition	Remaining lamp life		
	"Life"	100%	5%
Operated exclusively with Lamp Setting set to "Eco + Quiet"	Approx. 3,000 hours	Approx. 150 hours	Approx. 150 hours
Operated exclusively with Lamp Setting set to "Bright"	Approx. 2,000 hours	Approx. 100 hours	Approx. 100 hours

#### Note

- It is recommended that the lamp be changed when the remaining lamp life becomes 5%.
- The lamp life may vary depending on the usage condition.



# Troubleshooting with “Help” menu

This function advises you to solve the problems during usage.

## Utilizing “Help” menu functions

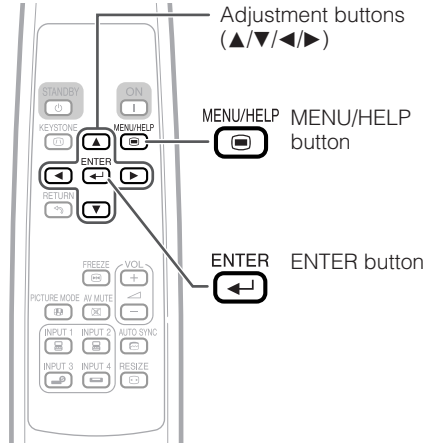

Example: When the picture has a green tint  
When the picture has a green tint on INPUT 1 (Component)/INPUT 2 (Component).

**1** Press MENU/HELP.

**2** Press or to select “Help”, then press ENTER.

**3** Press or to select “Color is faded or poor” on Help menu, then press ENTER.

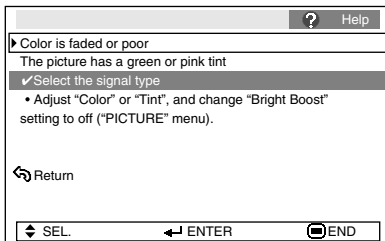
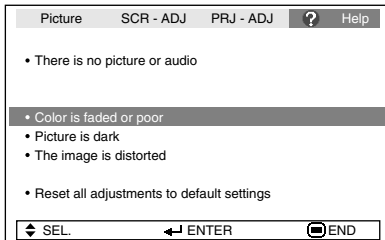

**4** Select “Select the signal type”, then press ENTER.

**5** Select “Component”, then press ENTER.

- If there are more items to be set after this, follow the instructions on the screen and select the best item for your needs.

### Note

- You can adjust the items with check marks (✓).
- The items in the “Help” menu change, depending on the input signal or setting that you have selected.
- **If the problem is not solved, refer to “Troubleshooting”. (see pages 55 and 56)**

# Maintenance

## Cleaning the projector

- Ensure that you have unplugged the power cord before cleaning the projector.
- The cabinet as well as the operation panel is made of plastic. Avoid using benzene or thinner, as these can damage the finish on the cabinet.
- Do not use volatile agents such as insecticides on the projector.  
Do not attach rubber or plastic items to the projector for long periods.  
The effects of some of the agents in the plastic may cause damage to the quality or finish of the projector.
- Wipe off dirt gently with a soft flannel cloth.
- When the dirt is hard to remove, soak a cloth in a mild detergent diluted with water, wring the cloth well and then wipe the projector. Strong cleaning detergents may discolor, warp or damage the coating on the projector. Make sure to test on a small, inconspicuous area on the projector before use.

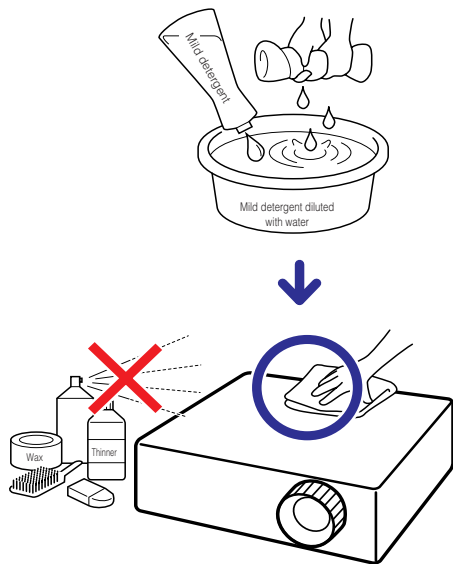

## Cleaning the lens

- Use a commercially available blower or lens cleaning paper (for glasses and camera lenses) for cleaning the lens. Do not use any liquid type cleaning agents, as they may wear off the coating film on the surface of the lens.
- As the surface of the lens can easily get damaged, be sure not to scrape or hit the lens.

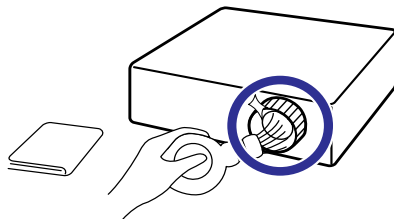

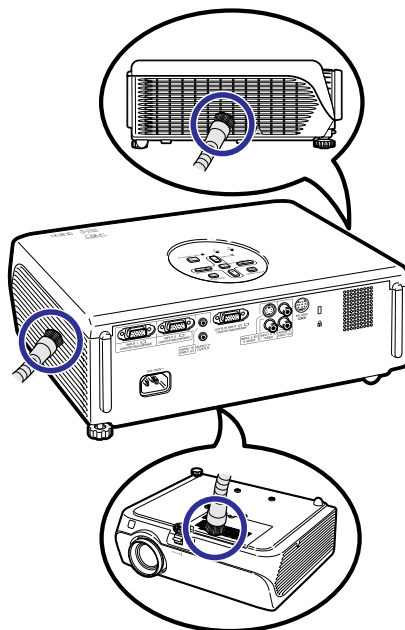

## Cleaning the exhaust and intake vents

- Use a vacuum cleaner to clean dust from the exhaust vent and the intake vent.



## Info

- If you want to clean the air vents during projector operation, be sure to press  STANDBY-ON on the projector or  STANDBY on the remote control and put the projector into standby mode. After the cooling fan has stopped, clean the vents.

# Maintenance Indicators

- The warning lights (power indicator, lamp indicator and temperature warning indicator) on the projector indicate problems inside the projector.
- If a problem occurs, either the temperature warning indicator or the lamp indicator will illuminate red, and the projector will enter standby mode. After the projector has entered standby mode, follow the procedures given below.

## Top View

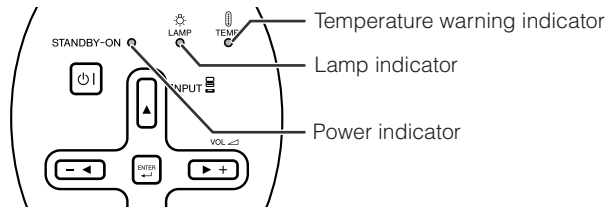

### About the temperature warning indicator



If the temperature inside the projector increases, due to blockage of the air vents, or the setting location, "TEMP." will illuminate in the lower left corner of the picture. If the temperature keeps on rising, the lamp will turn off and the temperature warning indicator will blink, the cooling fan will run, and then the projector will enter standby mode. After "TEMP." appears, be sure to perform the measures described on page 49.

### About the lamp indicator



- When the remaining lamp life becomes 5% or less, (yellow) and "Change The Lamp" will be displayed on the screen. When the percentage becomes 0%, it will change to (red), the lamp will automatically turn off and then the projector will automatically enter standby mode. At this time, the lamp indicator will illuminate in red.
- **If you try to turn on the projector a fourth time without replacing the lamp, the projector will not turn on.**

### Indicators on the Projector

Power indicator	Green on	Normal (Standby)
	Red on	Normal (Power on)
	Green blinks	Abnormal (See page 49.)
	Red blinks	Normal (Cooling)
Lamp indicator	Green on	Normal
	Green blinks	The lamp is warming up or shutting down.
	Red on	The lamp is shut down abnormally or requires to be changed. (See page 49.)
Temperature warning indicator	Off	Normal
	Red on	The internal temperature is abnormally high. (See page 49.)

	Maintenance indicator		Problem	Cause	Possible Solution
	Normal	Abnormal			
Temperature warning indicator	Off	Red on (Standby)	The internal temperature is abnormally high.	<ul style="list-style-type: none"> <li>Blocked air intake</li> </ul>	<ul style="list-style-type: none"> <li>Relocate the projector to an area with proper ventilation. (see page 8)</li> </ul>
				<ul style="list-style-type: none"> <li>Cooling fan breakdown</li> <li>Internal circuit failure</li> <li>Clogged air intake</li> </ul>	<ul style="list-style-type: none"> <li>Take the projector to your nearest EIKI Authorized Dealer or Service Center for repair.</li> </ul>
Lamp indicator	Green on (Green blinks when the lamp is warming up or turning off.)	Red on	The lamp does not illuminate.	<ul style="list-style-type: none"> <li>The lamp is shut down abnormally.</li> </ul>	<ul style="list-style-type: none"> <li>Disconnect the power cord from the AC outlet, and then connect it again.</li> </ul>
			Time to change the lamp.	<ul style="list-style-type: none"> <li>Remaining lamp life becomes 5% or less.</li> </ul>	<ul style="list-style-type: none"> <li>Carefully replace the lamp. (See page 51.)</li> <li>Take the projector to your nearest EIKI Authorized Dealer or Service Center for repair.</li> <li>Please exercise care when replacing the lamp.</li> <li>Securely install the cover.</li> </ul>
		Red on (Standby)	The lamp does not illuminate.	<ul style="list-style-type: none"> <li>Burnt-out lamp</li> <li>Lamp circuit failure</li> </ul>	
Power indicator	Green on/ Red on Red blinks (Cooling)	Green blinks	The power indicator blinks in green when the projector is on.	<ul style="list-style-type: none"> <li>The lamp unit cover is open.</li> </ul>	<ul style="list-style-type: none"> <li>If the power indicator blinks in green even when the lamp unit cover is securely installed, contact your nearest EIKI Authorized Dealer or Service Center for advice.</li> </ul>

### Info

- If the temperature warning indicator illuminates, and the projector enters standby mode, follow the possible solutions above and then wait until the projector has cooled down completely before plugging in the power cord and turning the power back on. (At least 10 minutes.)
- If the power is turned off for a brief moment due to power outage or some other cause while using the projector, and the power supply recovers immediately after that, the lamp indicator will illuminate in red and the lamp may not be lit. In this case, unplug the power cord from the AC outlet, replace the power cord in the AC outlet and then turn the power on again.
- The cooling fan keeps the internal temperature of the projector constant and this function is controlled automatically. The sound of the cooling fan may change during operation because the fan speed may change and this is not a malfunction.
- Do not unplug the power cord after the projector has entered standby mode and while the cooling fan is running. The cooling fan runs for about 90 seconds.



# Regarding the Lamp

## Lamp

- It is recommended that the lamp (sold separately) be replaced when the remaining lamp life becomes 5% or less, or when you notice a significant deterioration in the picture and color quality. The lamp life (percentage) can be checked with the on-screen display. (see page 45)
- Purchase a replacement lamp of type AH-11201 from your place of purchase, nearest EIKI Authorized Dealer or Service Center.

## Caution Concerning the Lamp

- This projector utilizes a pressurized mercury lamp. A loud sound may indicate lamp failure. Lamp failure can be attributed to numerous sources such as: excessive shock, improper cooling, surface scratches or deterioration of the lamp due to a lapse of usage time.  
The period of time up to failure largely varies depending on the individual lamp and/or the condition and the frequency of use. It is important to note that failure can often result in the bulb cracking.
- When the lamp replacement indicator and on-screen display icon are illuminated, it is recommended that the lamp be replaced with a new one immediately, even if the lamp appears to be operating normally.
- Should the lamp break, there is also a possibility that glass particles may spread inside of the projector. In such a case, it is recommended you contact your nearest EIKI Authorized Dealer or Service Center to assure safe operation.
- Should the lamp break, the glass particles may spread inside the lamp cage or gas contained in the lamp may be vented into the room from the exhaust vent. Because the gas in this lamp includes mercury, ventilate the room well if the lamp breaks and avoid all exposure to the released gas. In case of exposure to the gas, consult a doctor as soon as possible.

## Replacing the Lamp

- Do not remove the lamp unit from the projector right after use. The lamp will be very hot and may cause burn or injury.
  - **Carefully change the lamp by following the instructions described in this section. \* If you wish, you may have the lamp replaced at your nearest EIKI Authorized Dealer or Service Center.**
- \* If the new lamp does not light after replacement, take your projector to the nearest EIKI Authorized Dealer or Service Center for repair.

## Removing and Installing the Lamp Unit

### Warning!

- Do not remove the lamp unit from the projector right after use. The lamp and parts around the lamp will be very hot and may cause burns or injury.

### Info

- Make sure that you remove the lamp unit by the handle. Do not touch the glass surface of the lamp unit or the inside of the projector.
- To avoid injury to yourself and damage to the lamp, be sure to carefully follow the steps below.
- Do not loosen other screws except for the lamp unit cover and lamp unit.

- 1 Press  STANDBY-ON on the projector or  STANDBY on the remote control to put the projector into standby mode.**

- Wait until the cooling fan stops.

- 2 Disconnect the power cord.**

- Unplug the power cord from the AC socket.
- Leave the lamp until it has fully cooled down (about 1 hour).

- 3 Remove the lamp unit cover.**

- Turn the projector over. Loosen the user service screw (①) that secures the lamp unit cover. Remove the lamp unit cover (②).

Optional  
accessory

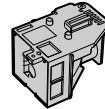

Lamp unit  
AH-11201

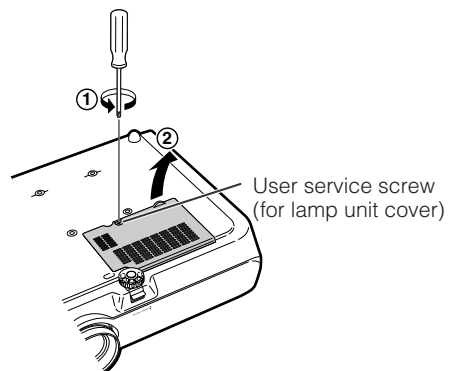
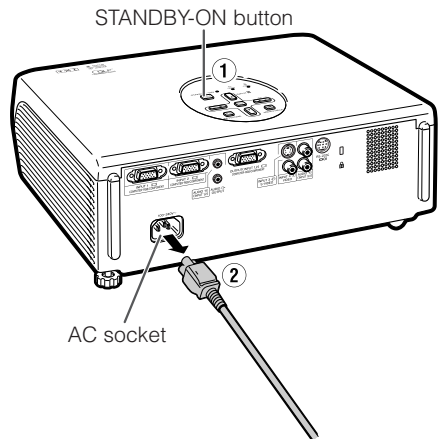

## Regarding the Lamp (Continued)

### 4 Remove the lamp unit.

- Loosen the securing screws from the lamp unit. Hold the lamp unit by the handle and pull it in the direction of the arrow. At this time, keep the lamp unit horizontal and do not tilt it.

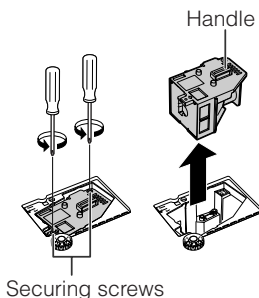

### 5 Insert the new lamp unit.

- Press the lamp unit firmly into the lamp unit compartment. Fasten the securing screws.

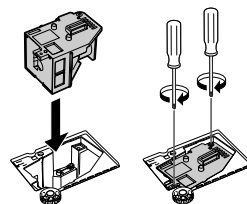

### 6 Replace the lamp unit cover.

- Align the tab on the lamp unit cover (1) and place it while pressing the tab (2) to close it. Then tighten the user service screw to secure the lamp unit cover.

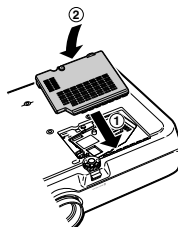

#### Info

- If the lamp unit and lamp unit cover are not correctly installed, the power will not turn on, even if the power cord is connected to the projector.

## Resetting the Lamp Timer

Reset the lamp timer after replacing the lamp.

#### Info

- Make sure to reset the lamp timer only when replacing the lamp. If you reset the lamp timer and continue to use the same lamp, this may cause the lamp to become damaged or explode.

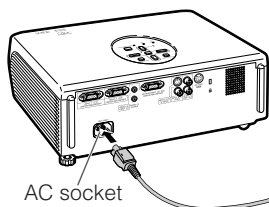

### 1 Connect the power cord.

- Plug the power cord into the AC socket of the projector.

### 2 Reset the lamp timer.

- While simultaneously holding down **MENU/HELP**, **ENTER** and **▼** on the projector, press **STANDBY-ON** on the projector.
- "LAMP 0000H" is displayed, indicating that the lamp timer is reset.

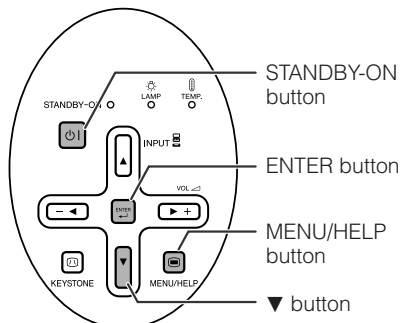



# Connecting Pin Assignments

## COMPUTER-RGB/COMPONENT INPUT1, 2 and COMPUTER-RGB/COMPONENT OUTPUT Terminals: 15-pin Mini D-sub female connector

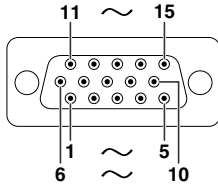

### COMPUTER-RGB Input/Output

1. Video input (red)
2. Video input (green/sync on green)
3. Video input (blue)
4. Not connected
5. Not connected
6. Earth (red)
7. Earth (green/sync on green)
8. Earth (blue)
9. Not connected
10. GND
11. Not connected
12. Bi-directional data
13. Horizontal sync signal: TTL level
14. Vertical sync signal: TTL level
15. Data clock

### Component Input/Output

1. PR (CR)
2. Y
3. PB (CB)
4. Not connected
5. Not connected
6. Earth (PR)
7. Earth (Y)
8. Earth (PB)
9. Not connected
10. Not connected
11. Not connected
12. Not connected
13. Not connected
14. Not connected
15. Not connected



# Computer Compatibility Chart

## Computer

- Multiple signal support  
Horizontal Frequency: 15-70 kHz,  
Vertical Frequency: 45-85 Hz,  
Pixel Clock: 12-108 MHz  
Sync signal: Compatible with TTL level
- Compatible with sync on green signal
- Compatible with the signals below in intelligent compression  
SVGA, XGA, SXGA, SXGA+
- Intelligent Compression and Expansion  
System resizing technology

The following is a list of modes that conform to VESA. However, this projector supports other signals that are not VESA standards.

PC/MAC	Resolution	Horizontal Frequency (kHz)	Vertical Frequency (Hz)	VESA Standard	Display		
PC	VGA	640 × 350	27.0	60		Upscale	
			31.5	70			
			37.5	85	✓		
		640 × 400	27.0	60			
			31.5	70			
			37.9	85	✓		
		720 × 350	27.0	60			
			31.5	70			
			37.9	85	✓		
		720 × 400	27.0	60			
				70			
				85	✓		
	31.5		50				
			60	✓			
			70	✓			
	640 × 480	26.2	50				
			60	✓			
			70	✓			
		34.7	70				
			72	✓			
			75	✓			
		43.3	85	✓			
			50				
			56	✓			
	SVGA	800 × 600	31.4	50		Intelligent Compression	
			35.1	56	✓		
			37.9	60	✓		
			46.6	70	✓		
			48.1	72	✓		
			48.9	75	✓		
		53.7	85	✓			
			50				
			60	✓			
XGA		1,024 × 768	48.4	60	✓		
			56.5	70	✓		
			60.0	75	✓		
	68.7	85	✓				
		60					
		66.2	70				
SXGA	1,152 × 864	67.5	75	✓			
		64.0	60	✓			
		64.0	60	✓			
SXGA+	1,280 × 1,024	64.0	60				
		64.0	60				
MAC 13"	VGA	640 × 480	34.9	67	Upscale		
MAC 16"	SVGA	800 × 600	37.8	60	Intelligent Compression		
		832 × 624	49.7	75			
MAC 19"	XGA	1,024 × 768	60.2	75			
MAC 21"	SXGA	1,152 × 870	68.7	75			





### Note

- When this projector receives 640 × 350 VESA format VGA signals, "640 × 400" appears on the screen.

## DTV

Signal	Horizontal Frequency (kHz)	Vertical Frequency (Hz)
480I	15.7	60
480P	31.5	60
540P	33.8	60
576I	15.6	50
576P	31.3	50
720P	45.0	60
1035I	28.1	50
1035I	33.8	60
1080I	28.1	50
1080I	33.8	60

# Troubleshooting

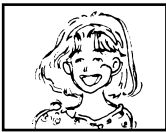
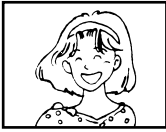
Problem	Check	Page
 No picture and no sound or projector does not start.	<ul style="list-style-type: none"> <li>Projector power cord is not plugged into the wall outlet.</li> </ul>	<b>28</b>
	<ul style="list-style-type: none"> <li>Power to the external connected devices is off.</li> </ul>	—
	<ul style="list-style-type: none"> <li>The selected input mode is wrong.</li> </ul>	<b>30</b>
	<ul style="list-style-type: none"> <li>Cables incorrectly connected to the projector.</li> </ul>	<b>23–27</b>
	<ul style="list-style-type: none"> <li>Remote control battery has run out.</li> </ul>	<b>14</b>
	<ul style="list-style-type: none"> <li>External output has not been set when connecting notebook computer.</li> </ul>	<b>25</b>
 Sound is heard but no picture appears (or picture is dark).	<ul style="list-style-type: none"> <li>The lamp unit cover is not installed correctly.</li> </ul>	<b>51, 52</b>
	<ul style="list-style-type: none"> <li>Cables incorrectly connected to the projector.</li> </ul>	<b>23–27</b>
	<ul style="list-style-type: none"> <li>“Bright” is set to minimum position.</li> </ul>	<b>42</b>
 Color is faded or poor.	<ul style="list-style-type: none"> <li>Image adjustments are incorrectly set.</li> <li>Make adjustments of “Color” and “Tint” in “Picture Mode” and lower the “Bright Boost” value.</li> </ul>	<b>42</b>
	(Video Input only) <ul style="list-style-type: none"> <li>Video input system is incorrectly set.</li> </ul>	<b>46</b>
 Picture is blurred; noise appears.	<ul style="list-style-type: none"> <li>Adjust the focus.</li> </ul>	<b>30</b>
	<ul style="list-style-type: none"> <li>The projection distance exceeds the focus range.</li> </ul>	<b>20</b>
	(Computer Input only) <ul style="list-style-type: none"> <li>Perform “Fine Sync” Adjustments (“Clock” Adjustment)</li> <li>Perform “Fine Sync” Adjustments (“Phase” Adjustment)</li> <li>Noise may appear depending on the computer.</li> </ul>	<b>46</b> <b>46</b> —
 Picture appears but no sound is heard.	<ul style="list-style-type: none"> <li>Cables incorrectly connected to the projector.</li> </ul>	<b>23–27</b>
	<ul style="list-style-type: none"> <li>Volume is set to minimum.</li> <li>When the projector is connected to an external device and the volume is set to minimum, the sound is not output even if you turn up the volume of the external device.</li> </ul>	<b>32</b>
	<ul style="list-style-type: none"> <li>“Speaker” is set to “Off”.</li> </ul>	<b>45</b>
An unusual sound is occasionally heard from the cabinet.	<ul style="list-style-type: none"> <li>If the picture is normal, the sound is due to cabinet shrinkage caused by room temperature changes. This will not affect operation or performance.</li> </ul>	—
Maintenance indicator on the projector illuminates or blinks in red.	<ul style="list-style-type: none"> <li>See “Maintenance Indicators”.</li> </ul>	<b>49</b>
The projector cannot be turned on or put into the standby mode using the STANDBY-ON button on the projector.	<ul style="list-style-type: none"> <li>The keylock is set. If the keylock is set to “ON”, all the buttons are locked.</li> </ul>	<b>29</b>

## Troubleshooting (Continued)

Problem	Check	Page
Picture is green on INPUT 1 (Component)/INPUT 2 (Component).	<ul style="list-style-type: none"> <li>Change the input signal type setting. Select "Color is faded or poor" in the "Help" menu, and then select an input signal type.</li> </ul>	46
Picture is pink (no green) on INPUT 1 (RGB)/INPUT 2 (RGB).		
Picture flickers on INPUT 1 (RGB)/INPUT 2 (RGB).	<ul style="list-style-type: none"> <li>Select "Initiate "Auto Sync" Adjustments" after selecting "Vertical stripes or flickering image appear" in the "Help" menu, and then press ENTER. If the picture hasn't improved, select "Adjust horizontal noise", and then press ENTER. After that, press ◀ or ▶ to adjust.</li> </ul>	46
Picture is too bright and whitish.	<ul style="list-style-type: none"> <li>Image adjustments are incorrectly set.</li> </ul>	42
The cooling fan becomes noisy.	<ul style="list-style-type: none"> <li>When temperature inside the projector increases, the cooling fan runs faster.</li> </ul>	—
The lamp does not light up even after the projector turns on.	<ul style="list-style-type: none"> <li>The lamp indicator is illuminating in red. Replace the lamp.</li> </ul>	48, 51
The lamp suddenly turns off during projection.		
The image sometimes flickers.	<ul style="list-style-type: none"> <li>Cables incorrectly connected to the projector or the connected equipment works improperly.</li> <li>Select "Vertical stripes or flickering image appear" in the "Help" menu and make the necessary adjustments.</li> <li>If this happens frequently, replace the lamp.</li> </ul>	23–27
		46
		51
The lamp needs much time to turn on.	<ul style="list-style-type: none"> <li>The lamp will eventually need to be changed. While the remaining lamp life draws to a close, replace the lamp.</li> </ul>	51
Picture is dark.		

This unit is equipped with a microprocessor. Its performance could be adversely affected by incorrect operation or interference. If this should happen, unplug the Unit and plug it in again after more than 5 minutes.

# Specifications

Product type	Projector
Model	EIP-1000T
Video system	NTSC3.58/NTSC4.43/PAL/PAL-M/PAL-N/PAL-60/SECAM/DTV480I/DTV480P/ DTV540P/DTV576I/DTV576P/DTV720P/DTV1035I/DTV1080I/DTV1080I-50
Display method	Single Chip Digital Micromirror Device™ (DMD™) by Texas Instruments
DMD panel	Panel size: 0.53", 1chip DMD
	No. of dots: 409,920 dots (854 [H] × 480 [V])
Lens	1–1.15 × zoom lens, F2.4–2.6, f = 19.0–21.9 mm
Projection lamp	275 W DC lamp
Component input signal	15-pin mini D-sub connector
(INPUT1/2)	Y: 1.0 Vp-p, sync negative, 75 Ω terminated P <sub>s</sub> : 0.7 Vp-p, 75 Ω terminated P <sub>R</sub> : 0.7 Vp-p, 75 Ω terminated
Horizontal resolution	520 TV lines (DTV720P)
Computer RGB input	15-pin mini D-sub connector
(INPUT 1/2)/output	RGB separate/sync on green type analog input: 0–0.7 Vp-p, positive, 75 Ω terminated
(OUTPUT) signal	HORIZONTAL SYNC. SIGNAL: TTL level (positive/negative) VERTICAL SYNC. SIGNAL: Same as above
S-video input signal	4-pin mini DIN connector
(INPUT 3)	Y (luminance signal): 1.0 Vp-p, sync negative, 75 Ω terminated C (chrominance signal): Burst 0.286 Vp-p, 75 Ω terminated
Video input signal	RCA connector: VIDEO, composite video, 1.0 Vp-p, sync negative, 75 Ω
(INPUT 4)	terminated
Vertical frequency	45–85 Hz
Horizontal frequency	15–70 kHz
Pixel clock	12–108 MHz
Audio input signal	ø3.5 mm minijack or RCA terminal: 0.5 Vrms, more than 22 kΩ (stereo)
Audio output signal	ø3.5 mm minijack: 0.5 Vrms, less than 2.2 kΩ
(AUDIO OUTPUT 1-4)	
Speaker system	4 cm × 2.85 cm oval × 1
Rated voltage	AC 100–240 V
Input current	3.6 A
Rated frequency	50/60 Hz
Power consumption	350 W (Lamp Setting "Bright")/ 305 W (Lamp Setting "Eco + Quiet") with AC 100 V 330 W (Lamp Setting "Bright")/ 285 W (Lamp Setting "Eco + Quiet") with AC 240 V
Power consumption (standby)	4 W (AC 100 V) – 5 W (AC 240 V)
Heat dissipation	1,315 BTU/hour (Lamp Setting "Bright")/ 1,145 BTU/hour (Lamp Setting "Eco + Quiet") with AC 100 V 1,240 BTU/hour (Lamp Setting "Bright")/ 1,070 BTU/hour (Lamp Setting "Eco + Quiet") with AC 240 V
Operating temperature	41°F to 95°F (+5°C to +35°C)
Storage temperature	–4°F to 140°F (–20°C to +60°C)
Cabinet	Plastic
I/R carrier frequency	38 kHz
Dimensions (approx.)	12 <sup>13</sup> / <sub>32</sub> " × 4 <sup>19</sup> / <sub>64</sub> " × 11 <sup>1</sup> / <sub>32</sub> " (315 (W) × 109 (H) × 280 (D) mm) (main body only) 12 <sup>13</sup> / <sub>32</sub> " × 4 <sup>47</sup> / <sub>64</sub> " × 11 <sup>37</sup> / <sub>64</sub> " (315 (W) × 120 (H) × 294 (D) mm) (including adjust- ment foot and projecting parts)
Weight (approx.)	8.6 lbs. (3.9 kg)
Replacement parts	Remote control, Power cord for U.S. and Canada, etc., Power cord for Europe, except U.K., 3 RCA to 15-pin D-sub adaptor, DIN-D-sub RS-232C adaptor, Owner's manual

*As a part of policy of continuous improvement, EIKI reserves the right to make design and specification changes for product improvement without prior notice. The performance specification figures indicated are nominal values of production units. There may be some deviations from these values in individual units.*



# Dimensions

Units: inches (mm)

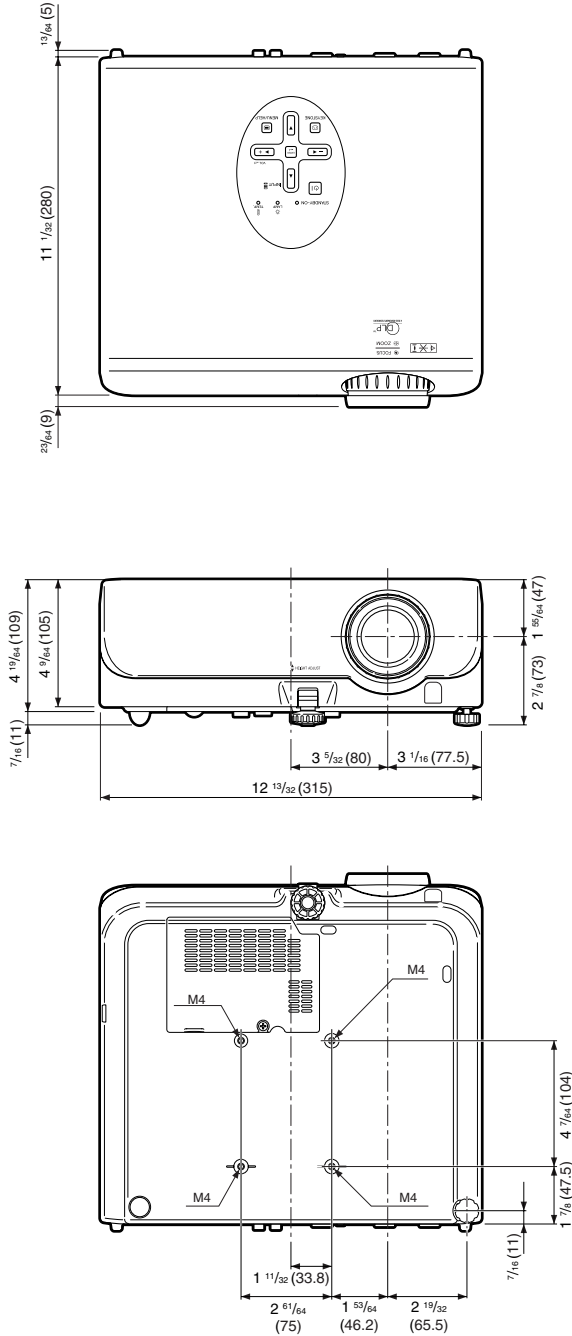

# Index

- AC socket ..... 28
- Accessories ..... 10
- Adjustment buttons ..... 39
- Adjust horizontal noise ..... 38, 46
- Adjust vertical noise ..... 38, 46
- Aspect ratio ..... 34
- AUDIO INPUT terminal ..... 23, 24, 25
- AUDIO OUTPUT terminal ..... 27
- Auto Power Off ..... 45
- Auto Search ..... 44
- Auto Sync
  - (Auto Sync adjustment) ..... 36, 38, 44
- AUTO SYNC button ..... 36
- AV MUTE button ..... 32
  
- Background ..... 43
- Blue ..... 42
- Bright ..... 42
- Bright Boost ..... 42
  
- CINEMA ZOOM ..... 34, 35
- Clock ..... 46
- CLR Temp (Color Temperature) ..... 42
- Color ..... 42
- Contrast ..... 42
  
- ENTER button ..... 39
- Exhaust vent ..... 12, 47
  
- Fan Mode ..... 45
- Fine Sync ..... 46
- Focus ring ..... 30
- FREEZE button ..... 36
- Front adjustment foot ..... 31
  
- H-Pos ..... 38, 46
- HEIGHT ADJUST lever ..... 31
- Help ..... 46
  
- INPUT 1 terminal ..... 23, 25, 26
- INPUT 1 – 4 modes ..... 30
- INPUT 2 terminal ..... 23, 25, 26
- INPUT 3 terminal ..... 24
- INPUT 4 terminal ..... 24
- INPUT buttons ..... 30
- Intake vent ..... 11, 12, 47
  
- Kensington Security
  - Standard connector ..... 12
- Keylock ..... 29
- KEYSTONE button ..... 33
- Keystone Correction ..... 43
  
- Lamp ..... 10, 50
- Lamp indicator ..... 48
- Lamp Setting ..... 42
- Lamp Timer (Life) ..... 45
- Lamp unit ..... 51
- Language (on-screen display language) ..... 43
- Lens Cap ..... 11
  
- MENU/HELP button ..... 39, 46
  
- ON button ..... 28
- Optional accessory ..... 10
- OSD Display ..... 43
- OUTPUT (INPUT1, 2) terminal ..... 26
  
- Phase ..... 46
- Picture Adjustment ..... 41
- Picture Mode ..... 36, 41
- PICTURE MODE button ..... 36
- Power cord ..... 28
- PRJ - ADJ ..... 44
- PRJ Mode ..... 19, 43
- Progressive ..... 42
  
- R-6 batteries ..... 14
- Rear adjustment foot ..... 31
- Red ..... 42
- Remote control ..... 13
- Remote control sensor ..... 15
- Replacing the lamp ..... 50, 51
- Resize ..... 34, 43
- RESIZE button ..... 34
- RETURN button ..... 39
- RGB cable ..... 25
  
- SCR - ADJ ..... 43
- Screen Size and Projection Distance ..... 20
- Sharp ..... 42
- SIDE BAR ..... 34, 35
- Speaker ..... 45
- STANDBY button ..... 29
- STANDBY-ON button ..... 28, 29
- STRETCH ..... 34, 35
- Supplied accessories ..... 10
- System Sound ..... 45
  
- Temperature warning indicator ..... 48
- Tint ..... 42
  
- Video System ..... 38
- Volume buttons ..... 32
- V-Pos ..... 38, 46
  
- Zoom ring ..... 30

# Index

- AC socket ..... 28
- Accessories ..... 10
- Adjustment buttons ..... 39
- Adjust horizontal noise ..... 38, 46
- Adjust vertical noise ..... 38, 46
- Aspect ratio ..... 34
- AUDIO INPUT terminal ..... 23, 24, 25
- AUDIO OUTPUT terminal ..... 27
- Auto Power Off ..... 45
- Auto Search ..... 44
- Auto Sync
  - (Auto Sync adjustment) ..... 36, 38, 44
- AUTO SYNC button ..... 36
- AV MUTE button ..... 32
  
- Background ..... 43
- Blue ..... 42
- Bright ..... 42
- Bright Boost ..... 42
  
- CINEMA ZOOM ..... 34, 35
- Clock ..... 46
- CLR Temp (Color Temperature) ..... 42
- Color ..... 42
- Contrast ..... 42
  
- ENTER button ..... 39
- Exhaust vent ..... 12, 47
  
- Fan Mode ..... 45
- Fine Sync ..... 46
- Focus ring ..... 30
- FREEZE button ..... 36
- Front adjustment foot ..... 31
  
- H-Pos ..... 38, 46
- HEIGHT ADJUST lever ..... 31
- Help ..... 46
  
- INPUT 1 terminal ..... 23, 25, 26
- INPUT 1 – 4 modes ..... 30
- INPUT 2 terminal ..... 23, 25, 26
- INPUT 3 terminal ..... 24
- INPUT 4 terminal ..... 24
- INPUT buttons ..... 30
- Intake vent ..... 11, 12, 47
  
- Kensington Security
  - Standard connector ..... 12
- Keylock ..... 29
- KEYSTONE button ..... 33
- Keystone Correction ..... 43
  
- Lamp ..... 10, 50
- Lamp indicator ..... 48
- Lamp Setting ..... 42
- Lamp Timer (Life) ..... 45
- Lamp unit ..... 51
- Language (on-screen display language) ..... 43
- Lens Cap ..... 11
  
- MENU/HELP button ..... 39, 46
  
- ON button ..... 28
- Optional accessory ..... 10
- OSD Display ..... 43
- OUTPUT (INPUT1, 2) terminal ..... 26
  
- Phase ..... 46
- Picture Adjustment ..... 41
- Picture Mode ..... 36, 41
- PICTURE MODE button ..... 36
- Power cord ..... 28
- PRJ - ADJ ..... 44
- PRJ Mode ..... 19, 43
- Progressive ..... 42
  
- R-6 batteries ..... 14
- Rear adjustment foot ..... 31
- Red ..... 42
- Remote control ..... 13
- Remote control sensor ..... 15
- Replacing the lamp ..... 50, 51
- Resize ..... 34, 43
- RESIZE button ..... 34
- RETURN button ..... 39
- RGB cable ..... 25
  
- SCR - ADJ ..... 43
- Screen Size and Projection Distance ..... 20
- Sharp ..... 42
- SIDE BAR ..... 34, 35
- Speaker ..... 45
- STANDBY button ..... 29
- STANDBY-ON button ..... 28, 29
- STRETCH ..... 34, 35
- Supplied accessories ..... 10
- System Sound ..... 45
  
- Temperature warning indicator ..... 48
- Tint ..... 42
  
- Video System ..... 38
- Volume buttons ..... 32
- V-Pos ..... 38, 46
  
- Zoom ring ..... 30

# EIKI

*A-Key to better communications*

## **U.S.A.**

EIKI International, Inc.  
30251 Esperanza  
Rancho Santa Margarita  
CA 92688-2132  
U.S.A.  
Tel : 800-242-3454 (949)-457-0200  
Fax: 800-457-3454 (949)-457-7878  
E-Mail : usa@eiki.com

## **Deutschland & Österreich**

EIKI Deutschland GmbH  
Am Frauwald 12  
65510 Idstein  
Deutschland  
Tel : 06126-9371-0  
Fax: 06126-9371-14  
E-Mail : info@eiki.de

## **Canada**

EIKI CANADA - Eiki International, Inc.  
P.O. Box 156, 310 First St. - Unit 2,  
Midland, ON, L4R 4K8, Canada  
Tel : 800-563-3454 (705)-527-4084  
Fax : 800-567-4069 (705)-527-4087  
E-Mail : canada@eiki.com

## **Eastern Europe**

EIKI CZECH spol. s.r.o.  
Umělecká 15  
170 00 Praha 7  
Czech Republic  
Tel : +42 02 20570024  
+42 02 20571413  
Fax : +42 02 20571411  
E-Mail : easterneurope@eiki.de

## **Japan & Worldwide**

EIKI Industrial Company Limited.  
4-12 Banzai-Cho, Kita-Ku, Osaka,  
530-0028 Japan  
Tel : +81-6-6311-9479  
Fax : +81-6-6311-8486

**WorldWide Website <http://www.eiki.com>**

Printed in China  
TINS-C058WJN1  
05P08-CH-NG